

PN7071

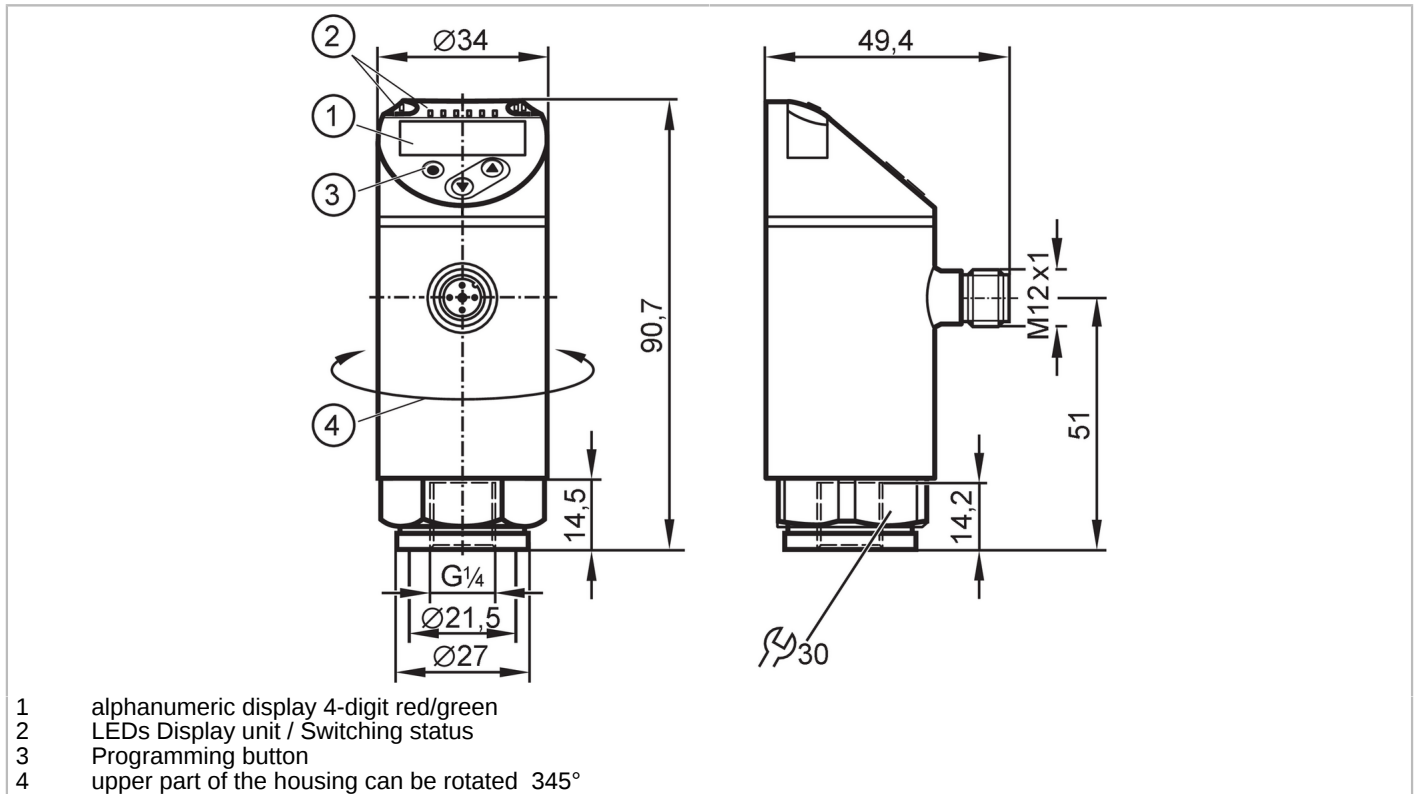

Pressure sensor with display

PN-250-SER14-QFRKG/US/ IV



Product characteristics

Number of inputs and outputs	Number of digital outputs: 2		
Measuring range	0...250 bar	0...3620 psi	0...25 MPa
Process connection	threaded connection G 1/4 Internal thread		

Application

Special feature	gold-plated contacts		
Measuring element	metallic thin film cell		
Application	for industrial applications		
Media	liquids and gases		
Medium temperature [°C]	-25...80		
Min. burst pressure	1100 bar	15950 psi	110 MPa
Pressure rating	500 bar	7250 psi	50 MPa
Vacuum resistance	-1000 mbar	-0.1 MPa	
Type of pressure	relative pressure		

Electrical data

Operating voltage [V]	18...30 DC; (to SELV/PELV)		
Current consumption [mA]	< 35		
Min. insulation resistance [MΩ]	100; (500 V DC)		
Protection class	III		
Reverse polarity protection	yes		
Power-on delay time [s]	< 0.3		
Integrated watchdog	yes		

PN7071



Pressure sensor with display

PN-250-SER14-QFRKG/US/ IV

Inputs / outputs			
Number of inputs and outputs	Number of digital outputs: 2		
Outputs			
Total number of outputs	2		
Output signal	switching signal; IO-Link; (configurable)		
Electrical design	PNP/NPN		
Number of digital outputs	2		
Output function	normally open / closed; (configurable)		
Max. voltage drop switching output DC [V]	2.5		
Permanent current rating of switching output DC [mA]	150; (200 (...60 °C) 250 (...40 °C))		
Switching frequency DC [Hz]	< 170		
Short-circuit protection	yes		
Type of short-circuit protection	yes (non-latching)		
Overload protection	yes		
Measuring/setting range			
Measuring range	0...250 bar	0...3620 psi	0...25 MPa
Factory setting / CMPT = 2			
Set point SP	2...250 bar	40...3620 psi	0.2...25 MPa
Reset point rP	1...249 bar	20...3600 psi	0.1...24.9 MPa
Min. difference between SP and rP	2 bar	20 psi	0.2 MPa
In steps of	1 bar	20 psi	0.1 MPa
Status_B High Resolution / CMPT = 3			
Set point SP	2...250 bar	30...3626 psi	0.2...25 MPa
Reset point rP	1...249 bar	12...3608 psi	0.1...24.9 MPa
Min. difference between SP and rP	2 bar	19 psi	0.2 MPa
In steps of	1 bar	1 psi	0.1 MPa
Accuracy / deviations			
Switch point accuracy [% of the span]	< ± 0,5		
Repeatability [% of the span]	< ± 0,1; (with temperature fluctuations < 10 K)		
Characteristics deviation [% of the span]	< ± 0,25 (BFSL) / < ± 0,5 (LS); (BFSL = Best Fit Straight Line; LS = limit value setting)		
Hysteresis deviation [% of the span]	< ± 0,25		
Long-term stability [% of the span]	< ± 0,05; (per 6 months)		
Temperature coefficient zero point [% of the span / 10 K]	0,2; (-25...80 °C)		
Temperature coefficient span [% of the span / 10 K]	0,2; (-25...80 °C)		

PN7071



Pressure sensor with display

PN-250-SER14-QFRKG/US/ IV

Reaction times									
Response time	[ms]	< 3							
Delay time programmable dS, dr	[s]	0...50							
Software / programming									
Parameter setting options	hysteresis / window; normally open / closed; switching logic; switch-on/switch-off delay; Damping; Display unit								
Interfaces									
Communication interface	IO-Link								
Transmission type	COM2 (38,4 kBaud)								
IO-Link revision	1.1								
SDCI standard	IEC 61131-9								
SIO mode	yes								
Required master port class	A; (when pin 2 not connected: B)								
Process data analog	1								
Process data binary	2								
Supported DeviceIDs	<table border="1"> <thead> <tr> <th>Type of operation</th> <th>DeviceID</th> </tr> </thead> <tbody> <tr> <td>Factory setting / CMPT = 2</td> <td>400</td> </tr> <tr> <td>Status_B High Resolution / CMPT = 3</td> <td>598</td> </tr> </tbody> </table>	Type of operation	DeviceID	Factory setting / CMPT = 2	400	Status_B High Resolution / CMPT = 3	598		
Type of operation	DeviceID								
Factory setting / CMPT = 2	400								
Status_B High Resolution / CMPT = 3	598								
Note	For further information please see the IODD PDF file at "Downloads"								
Factory setting / CMPT = 2									
Profiles	Smart Sensor - SSP 0	Generic Profiled Sensor							
	Function	Device identification							
	Function	Process data variable							
	Function	Device diagnosis							
Min. process cycle time	[ms]	2.3							
IO-Link resolution pressure	1 bar	0.1 MPa							
IO-Link process data (cyclical)	<table border="1"> <thead> <tr> <th>Function</th> <th>bit length</th> </tr> </thead> <tbody> <tr> <td>pressure</td> <td>14</td> </tr> <tr> <td>binary switching information</td> <td>2</td> </tr> </tbody> </table>	Function	bit length	pressure	14	binary switching information	2		
Function	bit length								
pressure	14								
binary switching information	2								
IO-Link functions (acyclical)	application specific tag								
Status_B High Resolution / CMPT = 3									
Profiles	Smart Sensor - SSP 3.1	Measuring Sensor							
	Common - I&D	Identification and Diagnosis							
Min. process cycle time	[ms]	3							
IO-Link resolution pressure	0.1 bar	0.01 MPa							
IO-Link process data (cyclical)	<table border="1"> <thead> <tr> <th>Function</th> <th>bit length</th> </tr> </thead> <tbody> <tr> <td>pressure</td> <td>16</td> </tr> <tr> <td>device status</td> <td>4</td> </tr> <tr> <td>binary switching information</td> <td>2</td> </tr> </tbody> </table>	Function	bit length	pressure	16	device status	4	binary switching information	2
Function	bit length								
pressure	16								
device status	4								
binary switching information	2								
IO-Link functions (acyclical)	application specific tag								
Operating conditions									
Ambient temperature	[°C]	-25...80							
Storage temperature	[°C]	-40...100							
Protection	IP 65; IP 67								

PN7071



Pressure sensor with display

PN-250-SER14-QFRKG/US/ IV

Tests / approvals		
EMC	DIN EN 61000-6-2	
	DIN EN 61000-6-3	
Shock resistance	DIN EN 60068-2-27	50 g (11 ms)
Vibration resistance	DIN EN 60068-2-6	20 g (10...2000 Hz)
MTTF [years]	214	
UL approval	UL approval number	J003
Pressure equipment directive	sound engineering practice; can be used for group 2 fluids; group 1 fluids on request	
Mechanical data		
Weight [g]	239.2	
Housing	tubular	
Dimensions [mm]	Ø 34 / L = 90.7	
Material	stainless steel (630/1.4542/17-4 PH); stainless steel (1.4404 / 316L); PBT+PC-GF30; PBT-GF20; PC	
Materials (wetted parts)	stainless steel (630/1.4542/17-4 PH)	
Min. pressure cycles	100 million	
Tightening torque [Nm]	25...35; (recommended tightening torque; Depends on lubrication, seal and pressure rating)	
Process connection	threaded connection G 1/4 Internal thread	
Restrictor element integrated	no (can be retrofitted)	
Displays / operating elements		
Display	Display unit	3 x LED, green (bar, psi, MPa)
	Switching status	2 x LED, yellow
	Measured values	alphanumeric display, red/green 4-digit
Remarks		
Pack quantity	1 pcs.	
Electrical connection		
Connector: 1 x M12; coding: A; Contacts: 4, gold-plated		

PN7071



Pressure sensor with display

PN-250-SER14-QFRKG/US/ IV

Connection



OUT1	Switching output IO-Link
OUT2	Switching output Colors to DIN EN 60947-5-2 Core colors :
BK =	black
BN =	brown
BU =	blue
WH =	white