

EVC04A

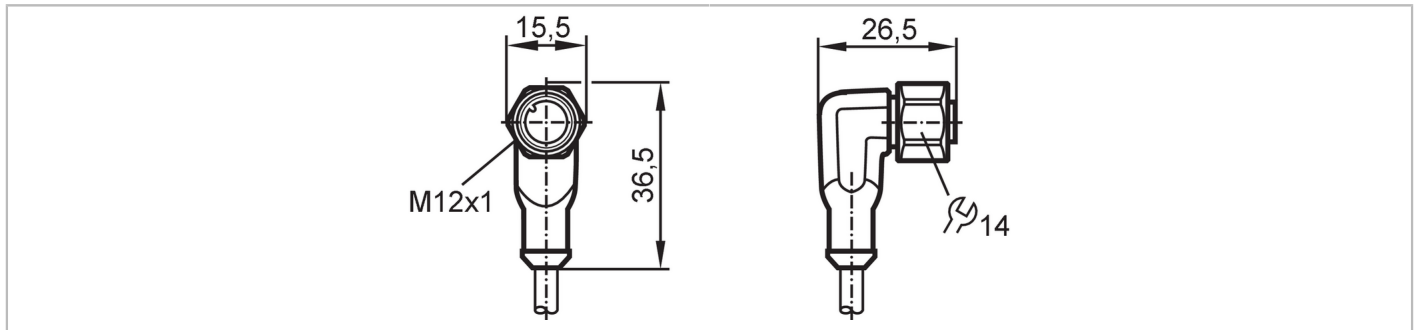

Female cordset

ADOAH040VAT0002H04/3G/2D



Application	
Special feature	Halogen-free; gold-plated contacts
Compatible with paint	yes
Electrical data	
Operating voltage [V]	< 60 AC/DC
Protection class	II
Max. current load total [A]	2
Operating conditions	
Ambient temperature [°C]	-20...60
Protection	IP 67; (when used outside the hazardous area: IP 68 / IP 69K)
Tests / approvals	
Approval	BVS 08 ATEX E 109 U; IECEx BVS 08.0041 U
ATEX marking	II 3G Ex ec IIC Gc; II 2D Ex tb IIIC Db IP65/IP67
Mechanical data	
Weight [g]	101.4
Dimensions [mm]	26.5 x 15.5 x 36.5
Molded-body material	TPU (urethane)
Material nut	stainless steel (1.4404 / 316L)
Sealing material	FKM
Remarks	
Pack quantity	1 pcs.
Electrical connection	
Cable: 2 m, PUR, Halogen-free, black, Ø 4.9 mm; 4 x 0.34 mm ² (42 x Ø 0.1 mm)	
Electrical connection - Socket	
Connector: 1 x M12, angled; coding: A; Contacts: 4, gold-plated; Moulded body: TPU (urethane), orange; Locking: stainless steel (1.4404 / 316L); sealing: FKM; Tightening torque: 1.2...1.5 Nm	

EVC04A



Female cordset

ADOAH040VAT0002H04/3G/2D

Connection

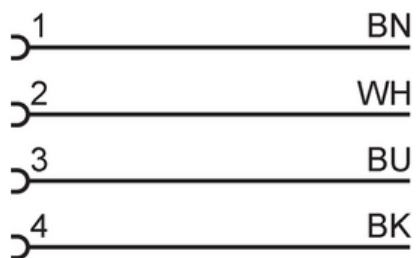

Core colors :
BK = black
BN = brown
BU = blue
WH = white