



Position sensors

It can take a beating! Robust position sensor for welding applications



Magnetic and cylinder sensors



Non-stick coating to prevent sticking of weld slag

Object detection through a cover to protect the sensor

Reliable switching signal even in cases of heavy soiling of the sensor

Robust and impact resistant thanks to active face made of metal

Space-saving design for limited space



Programmable timer function

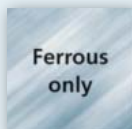

Ferrous only

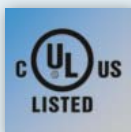

UL LISTED



IP 65
IP 67



IO-Link

Made for demanding environments

The new compact power pack from ifm is predestined for the rough environments in welding applications. Its non-stick coating prevents the sticking of weld slag, which simply rolls off the robust metal housing. Even in cases of heavy soiling and impact the sensor functions reliably and always guarantees safe operation.

Non-contact sensing through covers

The sensor can detect objects through non-ferromagnetic covers, an additional protection. The low-cost cover can be exchanged easily without any technical staff.



Type	Connection	Output	Protective coating	Weld field resistant	IO-Link	Order no.
------	------------	--------	--------------------	----------------------	---------	-----------

Operating principle: magnetically biased, detects steel

	2 m, PUR cable	PNP, NO	-	-	-	MQ2000
	0.3 m, PUR cable, M8 connector	PNP, NO	-	-	-	MQ2001
	2 m, PUR cable	PNP/ NPN programmable, NO / NC programmable	•	adjustable	•	MQ2003
	0.3 m, PUR cable, M12 connector	PNP/ NPN programmable, NO / NC programmable	•	adjustable	•	MQ2004
	0.3 m, PUR cable, M12 connector	PNP/ NPN programmable, NO / NC programmable	-	-	•	MQ2005

Dimensions

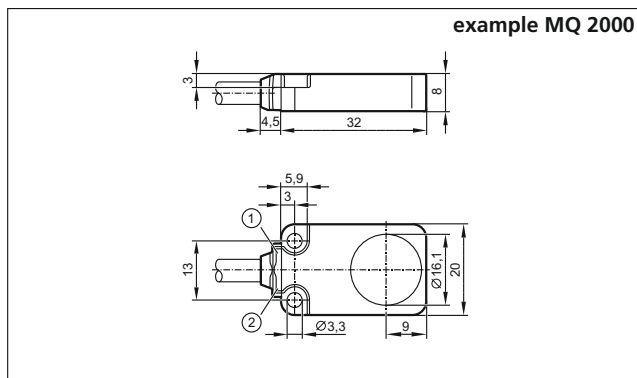

- 1) LED green
- 2) LED yellow

Wiring diagram

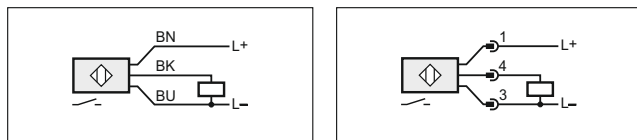

MQ2000

MQ2001

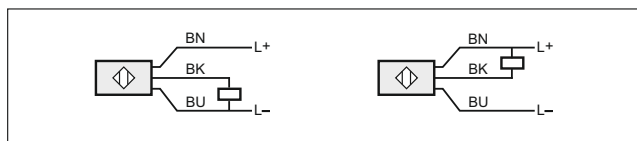

MQ2003

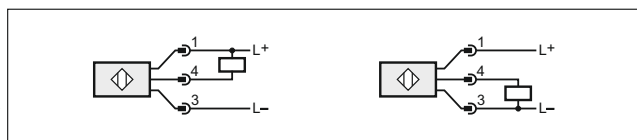

MQ2004, MQ2005

Common technical data

Operating voltage	[V DC]	10...30
Switching frequency	[Hz]	400
Sensing range	[mm]	5 flush
Reverse polarity protection / short-circuit protection		• / •
Protection rating		IP 65 / IP 67
Ambient temperature	[°C]	-25...80
Indication	switching status LED operating status LED	yellow green
Correction factor		mild steel (St37) = 1
Housing material		full metal



Accessories

Type	Description	Order no.
------	-------------	-----------

Installation

	Angle bracket, stainless steel	E12605
---	--------------------------------	---------------

IO-Link

	USB IO-Link master for parameter setting and analysis of units Supported communication protocols: IO-Link (4.8, 38.4 and 230 Kbits/s)	E30390
	LR DEVICE (supplied on USB flash drive) Software for online and offline parameter setting of IO-Link sensors and actuators	QA0011

Connection technology

	Socket, M12, 2 m grey, PUR cable, weld-field immune	EVW001
	Socket, M12, 5 m grey, PUR cable, weld-field immune	EVW002

We reserve the right to make technical alterations without prior notice. · 04.2019