



Process sensors



First G 1/2 pressure sensor with hygienic approval for small pipes



Pressure sensors



Maintenance-free PEEK sealing concept for G 1/2 fitting

A robust, tried-and-tested ceramic measuring cell free from pressure transducer liquids

Approved to industry-wide hygienic standards

✔ **Integrated temperature measurement removes need for multiple instruments**

✔ **Digital communication without A/D or EMC losses**



Ideal solution for hygienic production plants

The new PM15 pressure sensor has a unique flush sealing concept. This concept allows hygienic integration of small ceramic-capacitive measuring cells in small pipes, for example, in dosing and filling systems, which was not possible before. Thanks to the G 1/2 thread, it can be installed without requiring expensive adapters. Flush fitting makes it possible to use viscous media and guarantees optimum results for CIP processes. For each sensor, a factory certificate is available for free download.

Maintenance-free and robust

On the process side, the sensor is maintenance-free because it has no elastomer seal. The flush and robust ceramic measuring cell is resistant to pressure and vacuum shocks and to impact by abrasive substances. The sensor is resistant to medium temperatures of up to 150 °C (max. 1h).





Factory setting Measuring range [bar]	Measuring range Relative pressure [bar]	Pressure rating [bar]	Order no.
G 1/2 sealing cone, 4...20 mA, IO-Link			
0...40	-1...40	200	PM1543
0...25	-1...25	160	PM1503
0...16	-1...16	110	PM1514
0...10	-1...10	75	PM1504
0...6	-1...6	50	PM1515
0...4	-1...4	40	PM1505
0...2.5	-0.124...2.5	30	PM1506



Accessories

Type	Description	Order no.
------	-------------	--------------



Installation

	Welding adapter D29; pressure resistance 50 bar; stainless steel (1.4435 / 316L)	E43310
	T-piece; pressure resistance 40 bar; stainless steel (1.4404 / 316L)	E43316
	Zero point teach button, stainless steel (1.4404 / 316L); PA; FFKM; PBT	E30425

IO-Link

	LR DEVICE (supplied on USB flash drive) Software for online and offline parameter setting of IO-Link sensors and actuators	QA0011
	USB IO-Link master for parameter setting and analysis of units Supported communication protocols: IO-Link (4.8, 38.4 and 230 Kbits/s)	E30390

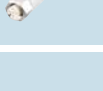
Connection technology

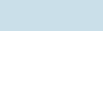
	Socket, M12, 4 poles 5 m, grey, MPPE cable	EVF001
	Socket, M12, 4 poles 10 m, grey, MPPE cable	EVF002
	Socket, M12, 4 poles 5 m, grey, MPPE cable	EVF004
	Socket, M12, 4 poles 10 m, grey, MPPE cable	EVF005

Common technical data

Operating voltage	[V DC]	18...30
Pressure monitoring		
Accuracy / deviation (in % of the span)		< ± 0.5
Deviation of the characteristics (DIN EN 61298-2)	[%]	< ± 0.5
Step response time	[ms]	30 (2L) / 7 (3L)
Analogue output		
Temperature monitoring (Via IO-Link)		
Accuracy	[K]	± 2.5
Dynamic response T05 / T09	[s]	< 10 / < 25
Medium temperature	[°C]	-25...125 (150 max. 1h)
Protection rating		IP 67 / IP 68 / IP 69K
Materials in contact with the medium		Ceramics (99.9 %, PTFE, stainless steel (1.4435 / 316L)
Communication interface		IO-Link 1.1 COM2 slave; 38.4 kbaud

Dimensions

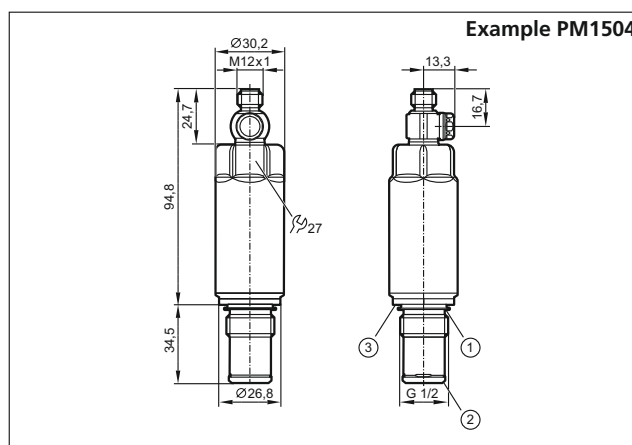

- 1) FKM sealing ring (for sealing between housing and process connection – not pressure resistant) / removable
- 2) Pre-mounted PEEK sealing ring (removable) / metal sealing area
- 3) Slot for sealing ring DIN 3869-21