



Process sensors

Better without a float: Maintenance-free capacitive level measurement



Level sensors



Optimised for use in hydraulic oils and coolants

No maintenance necessary, free from mechanical parts

Easy adjustment and setting of the output function via inductive teach button

- 2 configurable switching outputs defined by media or temperature
- Adjustment to different media (e.g. water/oil)



Reliable alternative for float switches

The LI level sensor is perfectly suited for the detection of level or leakage. The capacitive measurement technology has no moving parts, which eliminates mechanical failures due to deposits. This increases machine availability, saving maintenance costs and time.















Plug and play point level sensor with digital communication

The LI comes pre-programmed from the factory for use in water-based applications making installation plug and play. No additional setup is required for simple point level applications.

Additionally, the sensor outputs can be programmed via an inductive teach button or IO-Link digital communication can be used to get both point level and temperature over a single wire.



Accessories

Design	Description	Order no.
Mounting accessories		
	Mounting clamp for level sensors Ø 16 mm	E43000
	Mounting clamp for level sensors Ø 16 mm	E43016
Mounting adapters		
	Mounting adapter, G 3/4, stainless steel	E43003
	Installation adapter for level sensors, D16, stainless steel	E43004
	Flange plate for level sensors, 65-80 mm, anodised aluminium	E43006
	Flange plate for level sensors, 73-90 mm, anodised aluminium	E43001
	Flange plate for level sensors, 100-125 mm, anodised aluminium	E43005
	Mounting adapter for level sensors, D16; nickel-plated brass	E43019
	Flange plate for level sensors, 54-52 x 52 mm, anodised aluminium	E43007
	Mounting adapter for level sensors; 3/4" NPT, stainless steel	E43012
	Mounting adapter for level sensors; 1" NPT, stainless steel	E43013
Welding adapter		
	Welding adapter for level sensors Ø 50 mm, stainless steel	E43002
IO-Link accessories		
	USB IO-Link master for parameter setting and analysis of units Supported communication protocols: IO-Link (4.8, 38.4 and 230 Kbits/s)	E30390
	LR DEVICE (supplied on USB flash drive) Software for online and offline parameter setting of IO-Link sensors and actuators	QA0011

Probe length [mm]	Temperature water [°C]	Temperature oil [°C]	Order no.
2 switching outputs, 1 x temperature, 1 x level or 2 x level depending on the damping (e.g. water/oil)			
132	-10...85*	-10...85*	LI5131
273	-10...85*	-10...85*	LI5132
481	-10...85*	-10...85*	LI5133
737	-10...85*	-10...85*	LI5134

* Derating see data sheet

Further technical data

Operating voltage	[V DC]	9,6...35; (IO-Link: 18...30)
Ambient temperature	[°C]	-25...80
Process connection	[mm]	Ø 16
Protection rating, protection class		IP 68; IP 69K, III
Tank pressure	[bar]	0.5

Dimensions

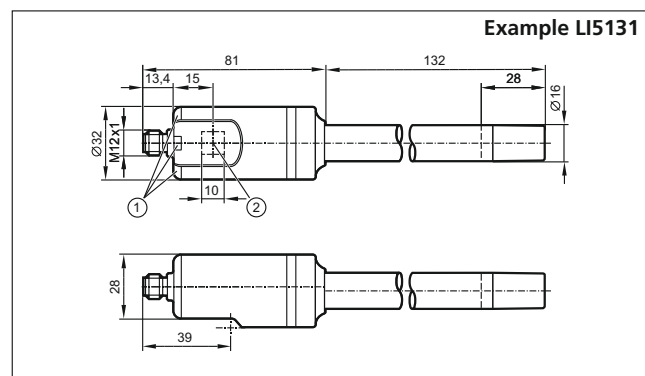

- 1) LED
- 2) inductive teach button

Wiring diagram

