



IO-Link

Safety over IO-Link



PROFIsafe IO-Link module



Safety module for IO-Link

8 safe OSSD inputs

4 powerful outputs with separate 24 V supply

PROFIsafe telegram tunnelled via IO-Link

Safety to SIL 3 and PLe

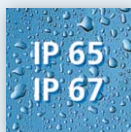

IO-Link for safety-related applications

Thanks to the transmission protocol "PROFIsafe", standard safety sensors and actuators can be operated via IO-Link. All you need is the PROFIsafe IO-Link module. It features 8 safe digital inputs (OSSD) and 4 safe outputs. The innovation: On the hardware side, the module is simply connected to a normal IO-Link master via IO-Link. The special PROFIsafe transmission telegram ensures a "tunnelled" connection with the safety controller within the normal IO-Link communication. It fulfils the safety levels SIL 3 to IEC 61508 / EN 61508 and PLe to EN ISO 13849-1.

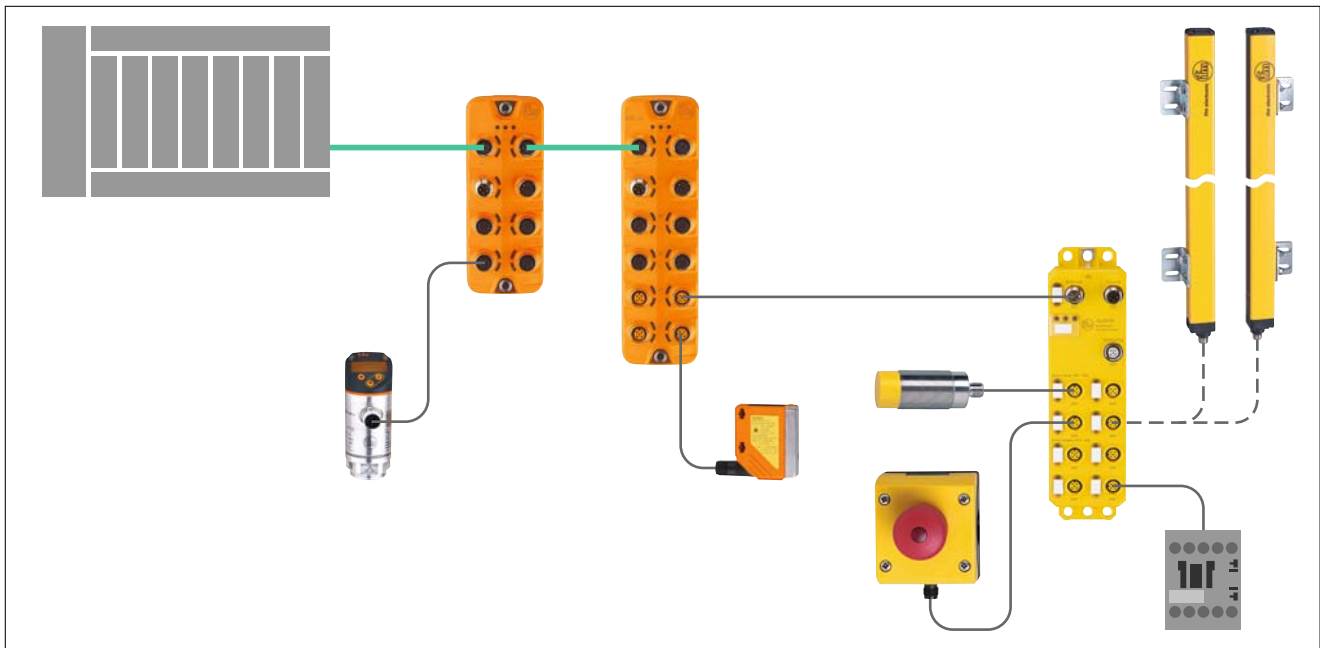

Powerful safe outputs

A separate 24 V supply via L-coded M12 sockets enables connection of powerful actuators. The outputs can be configured as PNP or NPN.











Accessories



Type	Description	Order no.
------	-------------	-----------

IO-Link master PerformanceLine Coolant		
	Profinet, 4-port	AL1400
	Profinet, 8-port	AL1402

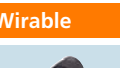
Accessories for AL200S		
	PROFIsafe address plug	E7700S

M12 socket, connection cable 2.5 mm ² , L-coded (power)	M12 - open	M12 - M12
	1 m	- E12653
	2 m	E12641 E12654
	5 m	E12642 E12655
	10 m	E12643 E12656

M12 connection cable 0.34 mm ² (sensor)		
	1 m	- EVC042
	2 m	- EVC043
	5 m	- EVC044
	10 m	- EVC493

Wirable		
	M12 connector L-coded (power)	- E12673
	M12 socket L-coded (power)	- E12672

On the hardware side, the PROFIsafe IO-Link module is connected to an A or B port of an AL1400 or AL1402 IO-Link master.

The safety module is powered via a separate L-coded M12 cable.

The "PROFIsafe" transmission protocol ensures tunnelled safety communication with the safety controller.

Easy replacement of units through address plug

The PROFIsafe address plug E7700S enables simple and fast replacement of the AL200S without a computer and without additional software. This memory plug is simply plugged into the new AL200S and the stored PROFIsafe address is automatically transferred to the new PROFIsafe IO-Link module.

Technical data PROFIsafe IO-Link module		Order no. AL200S
Operating voltage	[V DC]	19.2...30.2; (US; to SELV/PELV)
Additional voltage supply	[V DC]	19.2...30.2; (UA)
Actuator supply UA		
Total current rating	[A]	6
Current rating per port	[A]	2
IO-Link version		1.1
IO-Link transmission type		COM3
Number of inputs / outputs		8 / 4
Safety classification		
1-channel (ISO 13849-1)		PL d
1-channel (IEC 61508)		SIL 2
2-channel (ISO 13849-1)		PL e
2-channel (IEC 61508)		SIL 3
Protection rating		IP 65, IP 67
Ambient temperature	[°C]	-25...60

We reserve the right to make technical alterations without prior notice. · 11.2020