



ifm Australian Catalogue 2026

Industrial automation solutions - sensors, software & systems

**As of 1 July 2026, a 2% price adjustment has been applied to all products.*

Robotics & assembly automation

Food & beverage manufacturing

Water processing technology

Energy generation

Packaging automation

Facilities automation

Mining automation

Mobile machine controls

Logistics automation

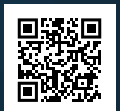

Free Freight on All Orders Under 20kg!

Deliveries for >20kg are charged based on weight and shipping destination.



Chairmen of the Board and co-CEOs Michael Marhofer and Martin Buck

Acting sustainably is ifm's motto

What will the world look like in the future? We at ifm ask ourselves this question not only when it comes to product development, innovative technologies and new ways of working. Environmental issues also play a leading role in our daily decisions and actions.

"Because we are all responsible for the future which takes social, economic, and ecological aspects into consideration."

We can only fulfil this responsibility when we are aware of the consequences of our actions and in time start looking for solutions and new ways to minimise their impact. For us, this also means responsibly and reliably following long-term goals instead of resting on short-term successes. In the course of this, we would like to recommend our fourth Sustainability report (reporting year 2023) which contains a comprehensive sustainability programme in addition to our strategic approaches and measures.

Acting sustainably is the motto - and in all respects. This is already stated in the corporate philosophy, first written down in 1990:

"ifm demands and promotes ecologically conscious decisions and conduct." ifm corporate philosophy.

The group of companies has been following this guiding principle for over 50 years. In doing so, we often go beyond the legal requirements and feel further encouraged in our thinking by the increasing attention to issues such as the protection of biodiversity, energy and mobility, which are emerging, among other things, from a global climate movement and also from pioneering measures of the European Green Deal.

One thing is certain for us:

"Efficient, socially balanced and ecologically compatible development is needed, whereby social interaction, economic strength and environmental protection are not contradictory for us." ifm corporate philosophy.

At the same time, we are aware that we must contribute more. Only then can we master the global social and ecological challenges. Up until now, we have seen ourselves as a company that operates sustainably in an integrated manner. Now we want to actively advance our sustainability activities and pursue the issues that are essential for us in the coming years. You can find out here what this means in detail for the ifm group.



Chairmen of the Board and co-CEOs: Martin Buck and Michael Marhofer

As a company that operates sustainably, we at ifm set ourselves the goal of harmonising economic, ecological and social aspects and anchoring them more firmly in our organisation.

The guiding principle of corporate sustainability describes a principle of action which is based in a balanced way on the three pillars of sustainability - Economy, Environment (ecology) and Social issues - in all corporate decisions and actions. Issues such as environmental protection, upholding social principles and economic stability are not fundamentally new, but they have become much more important in the past years.

ifm acts according to the principle of economic optimum and against this background strives for balance as well as commitment in all three dimensions.

"Looking to the future, we are also following our guiding principle growing successfully in security."



ifm electronic is committed to help your business succeed!



German quality industrial product, ex-stock AU

Personal service:

Either by phone, email, in person or via an MS Teams online meeting, ifm is always there for you – anywhere, anytime. We process your purchase orders, issue test samples and provide accurate technical and pricing information to support your business as efficiently as we can.

Workshops / Seminars:

To help introduce the pipeline of new ifm products and technology innovations, we can support you with hands-on workshops at your company, or at our training centre.

Meet an ifm engineer:

Interested in discovering new possibilities for your business or production process? Wish to discuss advanced technologies and solve technical problems? Or seek practical insights into the latest automation practices? Why not meet one of our engineers - either at your premises, or at our customer service centre. Or visit us at a Tradeshow. Whichever is your preference - we will look forward to hearing from you!



Scan here to register for your my ifm account, order online 24/7

my ifm - online orders:



Order 24/7

Use your 'my ifm' account to check product availability, list and net prices, and to place orders at any time.



Individual offers

Request a quote from customer service, or generate your own binding offer using 'my ifm'.



Fast / free delivery

Whether overnight or by forward date: You decide when your goods arrive (min. order value \$100).



Returns

If an item you receive is not quite right? Return it with no hassle (T&Cs apply).



Competent service

Our service centre staff are there for you if you have questions or need advice.

Introducing ifm electronic

This ifm Product Catalogue is designed to provide a comprehensive view of popular products and solutions typically stocked in Australia.

ifm electronic ltd:

We proudly support the Australian market with high-quality instrumentation and control solutions, backed by large local stock for fast delivery. The company now employs a dedicated team of 68 local employees, committed to help you and your business succeed. Located throughout the country in Melbourne, Sydney, Brisbane, Adelaide, Launceston and Perth, servicing 6,000 local businesses, and delivering 76% of all PO's overnight via couriers - nationwide!

ifm electronic - global:

ifm electronic gmbh is a family-owned German company founded in 1969, built on continuous investment in R&D and automated manufacturing. We offer a comprehensive range of sensors, control products, and connection solutions for industrial automation, supporting customers in industries where quality and reliability are essential. With 8,760 employees across 145 countries serving more than 165,000 customers, we've grown globally while preserving the flexibility, customer focus, and values of our founding years.

ifm Innovation:

As one of the world's leading manufacturers of industrial sensors and control products, ifm is known for robust, compact, and user-friendly designs with flexible outputs. With significant annual investment in R&D, we hold over 1,300 worldwide patents and continue to earn major design awards for innovation and breakthrough technologies.



Our commitment to you:







ifm products are distinguished by the highest precision and reliability. You have our word on that – hence the 5-year factory under written warranty!

We want you to use our products, confident that ifm is the right partner for your automation goals.

ifm – close to you!

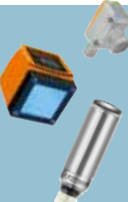

Product index

 IO-Link products	Industry 4.0 - why and how explained IO-Link masters & accessories <i>Pages: 4</i> <i>A point-to-point communication interface that connects smart sensors and actuators to a control system.</i>			
 IO-Link Masters Power supplies	IO-Link masters, expansion modules, bluetooth & accessories <i>Pages: 10</i>	IO-Link signal converters <i>Pages: 15</i>	Power supplies & ethernet cables <i>Pages: 16</i> <i>Switched mode power supplies</i>	Circuit monitoring & protection <i>Pages: 17</i> <i>Programmable circuit breakers using IO-Link technology.</i>
 ifm controllers & software solutions	ifm PLC and HMI controllers <i>Pages: 18</i>	Edge gateways <i>Pages: 19</i>	Moneo software <i>Pages: 20</i> <i>IIOT plant monitoring platform for industry</i>	
 Wiring technology	M12 cordsets <i>Pages: 24</i> <i>4 - 5 - 8-pin DC cordsets and field wirable connectors.</i>	M8 cordsets <i>Pages: 34</i> <i>3 - 4-pin DC cordsets and field wirable connectors.</i>	M12 - L coded cables <i>Pages: 37</i>	M12 splitter block systems <i>Pages: 39</i> <i>Four port and eight port M12 wiring blocks, patch cords and Y-splitters.</i>
 Position sensors	Magnetic sensors <i>Pages: 42</i> <i>Non-contact magnetic sensors detect metallic targets.</i>	Inductive sensors <i>Pages: 42</i> <i>Non-contact inductive sensors detect metallic targets.</i>	Valve sensors <i>Pages: 48</i> <i>Continuous position feedback and open closed feedback options.</i>	Cylinder sensors <i>Pages: 50</i> <i>Low-profile T-slot and C-slot cylinder sensors detect cylinder position.</i>
 Motion control	Inclination sensors <i>Pages: 52</i>	Speed monitors, rotation & standstill monitors <i>Pages: 53</i>	Encoders <i>Pages: 54</i> <i>Incremental and absolute encoders.</i>	
	Capacitive sensors <i>Pages: 56</i> <i>Capacitive sensors detect non-metallic targets, e.g. plastic, glass and wood.</i>	Capacitive touch buttons <i>Pages: 57</i> <i>Capacitive touch sensors.</i>		
 Position sensors	Photoelectrics & lasers <i>Pages: 58</i> <i>Visible red and laser provide long-range detection.</i>	Distance, colour and contrast <i>Pages: 64</i> <i>Photoelectric solutions for long ranges, color and contrast applications</i>	Laser distance sensors <i>Pages: 65</i>	Light grids <i>Pages: 68</i> <i>East object monitoring in intralogistics</i>



Vision sensors

Code reader & pixel counter

Pages: 70
For automated packaging codes.

2D contour sensor

Pages: 72
For automated packaging 2D profiles.

3D image sensor

Pages: 74
Volumetric control, missing goods applications.

Contour profiler

Pages: 77
PMD profiler for precise detection and QA checks.



Process displays

Light towers

Pages: 78
Single or multiple segments.



Safety products

Light curtains

Pages: 80
Light curtains offer a hands-free solution to protect personnel.

Safety relays & safety sensors

Pages: 82

Ultrasonic

Pages: 84
Ultrasonic object detection for transparent objects.

Process displays & signal evaluation

Pages: 85



Process sensors

Pressure sensors

Pages: 88
Sensors to monitor pressure in hydraulics and pneumatic systems. Also Hydrostatic level applications.

Level & distance sensors

Pages: 99
Point and continuous level sensors detect level of liquids, powders, granular solids and plastics.

Liquid flow sensors

Pages: 108
Flow sensors, mag-meters, and ultrasonic flow meters detect the flow rate of liquids.

Compressed air & gas flow sensors

Pages: 116
Flow sensors for compressed air and industrial gases.

Temperature sensors

Pages: 118
Modular temperature monitoring products provide feedback in temperature control applications.

Humidity sensor

Pages: 128

Oil condition sensors

Pages: 129

Conductivity sensors

Pages: 130
Conductivity application case study

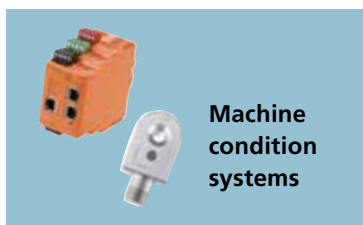

Machine condition systems

Vibration sensors & machine condition monitoring solutions

Pages: 132
Continuously monitor machine's vibration level to prevent equipment failure.



Industrial networks & Identification systems

RFID

Pages: 139
A high frequency or UHF platform. The antennas are able to read/write multiple tags up to 10 meters.

CAN BUS controllers & sensors for mobile machines

Pages: 140

Mobile machine connectors & control cables

Pages: 146

AS-i networking

Pages: 148
Networks sensors and actuators with plug-and-play functionality.

IO-Link explained

Industrial communications networking standard IEC 61131-9



Learn more

What is IO-Link?

IO-Link is an open standard communications protocol that is supported globally by over 500 sensor and control manufacturers, and growing.

The digital, bi-directional, point-to-point interface integrates with virtually any automated system. Resulting in a 100% digital path to your PLC from field-mounted sensors.

Unlike a fieldbus system, it works using a straightforward point-to-point communication method, using conventional 3-wire sensor and actuator connections.

IO-Link: Why, What and How?

After 40 years of traditional PLC communication, IO-Link has evolved as the **new global communication standard (IEC 61131-9)** transforming how industry connects and communicates with digital sensors and actuators.

Using wired or wireless configurations, this advanced technology overcomes integration challenges, allowing devices to seamlessly share enriched data sets.

Unlock the potential of your machines with digital communication

Plant operators can now get far more information, without increasing cost, engineering time or complexity.

In fact, existing infrastructure can already provide more, given that sensors and actuators are the “eyes and ears” of equipment condition.

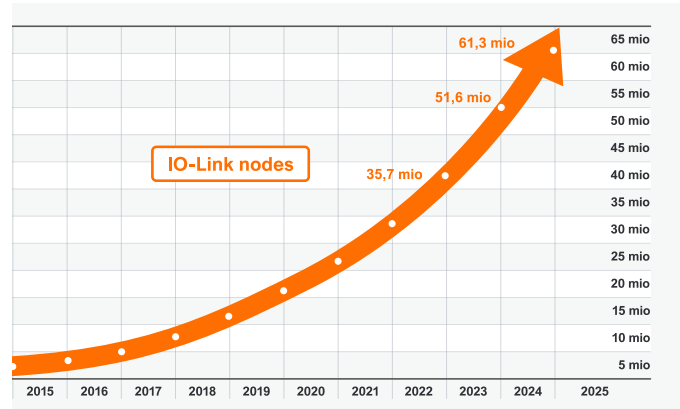

Enhanced digital communication unlocks the existing data in your system. With IO-Link data, you get access to real-time process data, parameter data, and predictive data that’s more reliable and accurate than what an analog signal has traditionally provided via HART and traditional controller communication protocols.

What is an IO-Link Master?

IO-Link masters replace traditional analog input cards, with a digital communication path between the IO-Link master and IO-Link device.

Up to 8 IO-Link devices such as sensors, actuators, valve feedback, and I/O modules, can be connected to a single master, depending on the configuration of the master.

The master transmits machine data, process parameters, and diagnostic information to a PLC controller, or directly to a higher level IIoT controls system.

	Sensor communication systems			
	Binary	Analog	IO-Link	Ethernet
Amount of data	1 bit	16 bit	32 bytes	QTY bytes
Sensor diagnostics			✓	✓
Remote sensor parameterisation			✓	✓
Automatic sensor parameterisation			✓	✓
Standard sensor cordsets	✓	✓	✓	
Digital communication			✓	✓
Complexity to integrate	✓	✓ ✓	✓ ✓	✓ ✓ ✓
Cost of ownership	\$	\$ \$	\$	\$ \$ \$

► Analog vs. IO-Link digital

Conventional: Analog signals require multiple analog-to-digital conversions that affect the accuracy of the sensor's output signal.



IO-Link: Requires only one analog-to-digital conversion. This avoids conversion losses of up to 1% accuracy.



1



Pure digital signal: IO-Link transmits a pure digital signal value that is noise-immune and more reliable than conventional analog signals.

2



Recipe changes: Recipe changes can be made to multiple sensors from your controller. Downtime and production changeover is minimized.

► Sensor parameterization

Conventional: Change parameters via on-board pushbuttons.



IO-Link: Sensors can be parameterized remotely by PLC.



3



Remote parameterization: Access to all available parameters of the sensors can be reached through the plc without the need for external software and local sensor display.

4



Simple plug-and-play sensor replacement: IO-Link restores the sensor or actuator parameters automatically when replacing and servicing the sensors.

► Automatic device replacement

Conventional: If a sensor needs to be replaced, the sensor must be re-programmed with pushbuttons.



IO-Link: Data is automatically uploaded to a sensor. No need for manual parameterization.

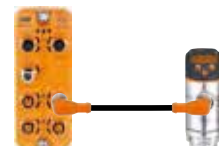

5



Sensor health: On existing wiring, additional diagnostic information can be transferred for easier fault location and predictive indication.

► Diagnostic information for predictive maintenance

Conventional: It is not possible to obtain diagnostic information without changing or adding wiring in the PLC.

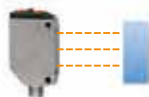

Ex. Clean lens 100% excess gain

IO-Link: Transfers diagnostic information on existing wiring allowing for predictive maintenance.



Ex. Dirty lens 40% excess gain

6



Not a fieldbus dependent system: IO-Link can be added to most existing control architectures with minimal cost.

IO-Link System technology advances



Typical controls architecture - process tank monitoring

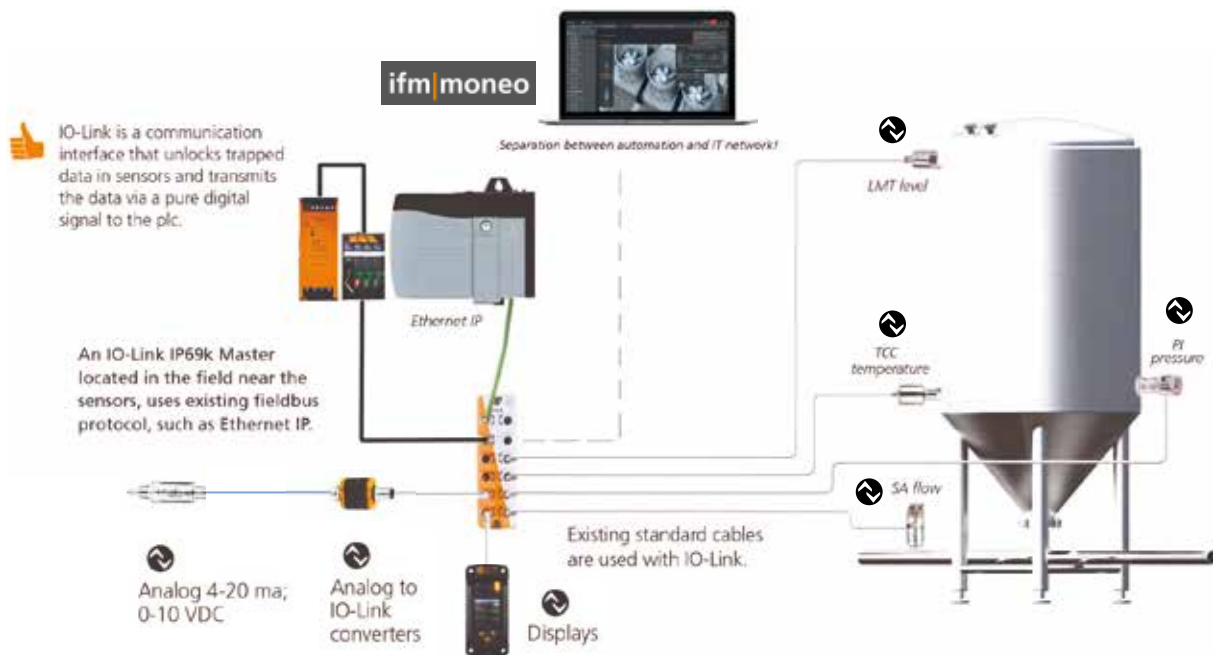

Ethernet I/O modules - Dataline

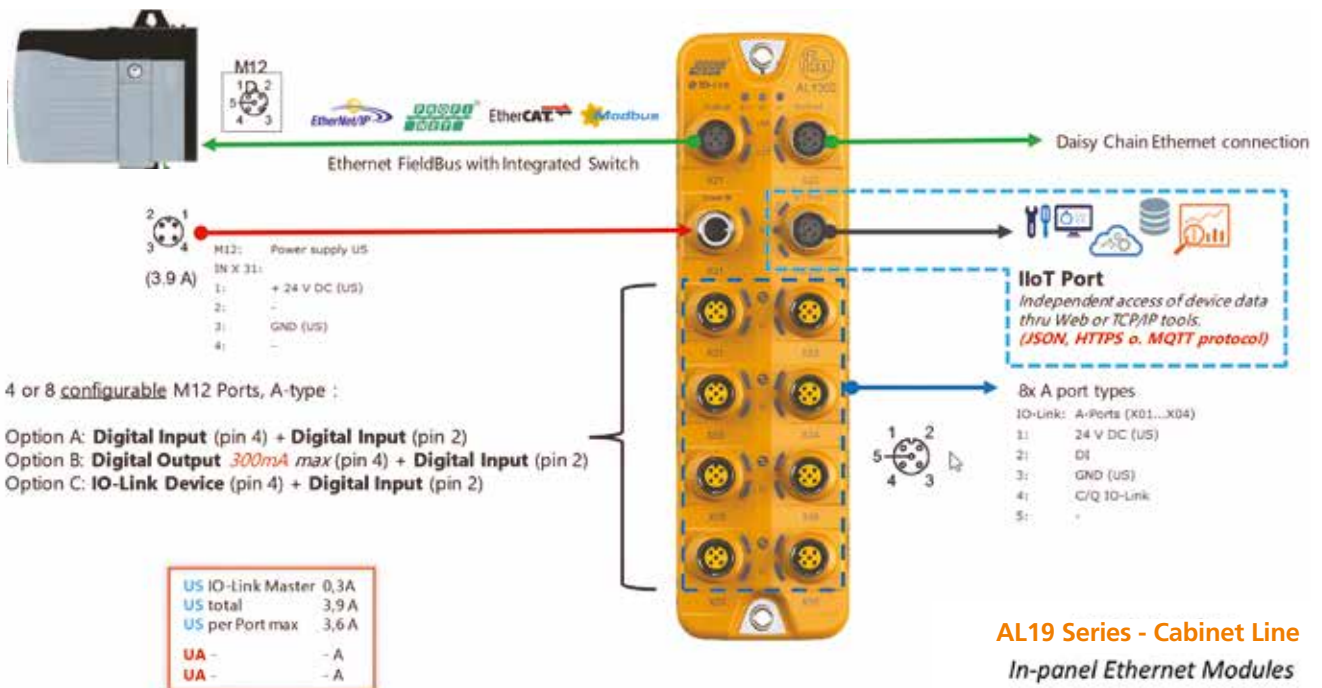

AL19 Series - Cabinet Line In-panel Ethernet Modules



Industry 4.0 Challenge

Industry 4.0 challenge, when it comes to managing large systems. Efficient data management with an OPC UA server and IODD interpreter is crucial for minimizing unnecessary data sent to the PLC. Additionally, complex cabling in extensive systems can significantly increase installation efforts and costs.

Industry 4.0 SolutionBlock

The Industry 4.0 SolutionBlock addresses these challenges head-on. By enabling Fieldbus, Power, and IIoT connectivity to be daisy-chained from master to master. Substantially reducing both cabling & cost. The ifm SolutionBlock is the first IO-Link master on the market to feature 2x IIoT ports, making it a groundbreaking innovation in this space.

1 Suitable for sensors with multiple process data

Plant control is relieved (data reduction).

Flexible thanks to multi-protocol

Free choice of fieldbus reduces storage space requirements.

Fewer cables required thanks to daisy chain

SolutionBlock is the first IO-Link master on the market to be equipped with 2 IIoT ports.

2 Reduction of workload and time required

SolutionBlock can be configured using the moneo|configure software.

The add-on PLC tool (GSDML generator) is available for Profinet in moneo.

Error-free and easy digitalisation

8 ports for a direct connection of sensors and actuators (IO-Link devices).

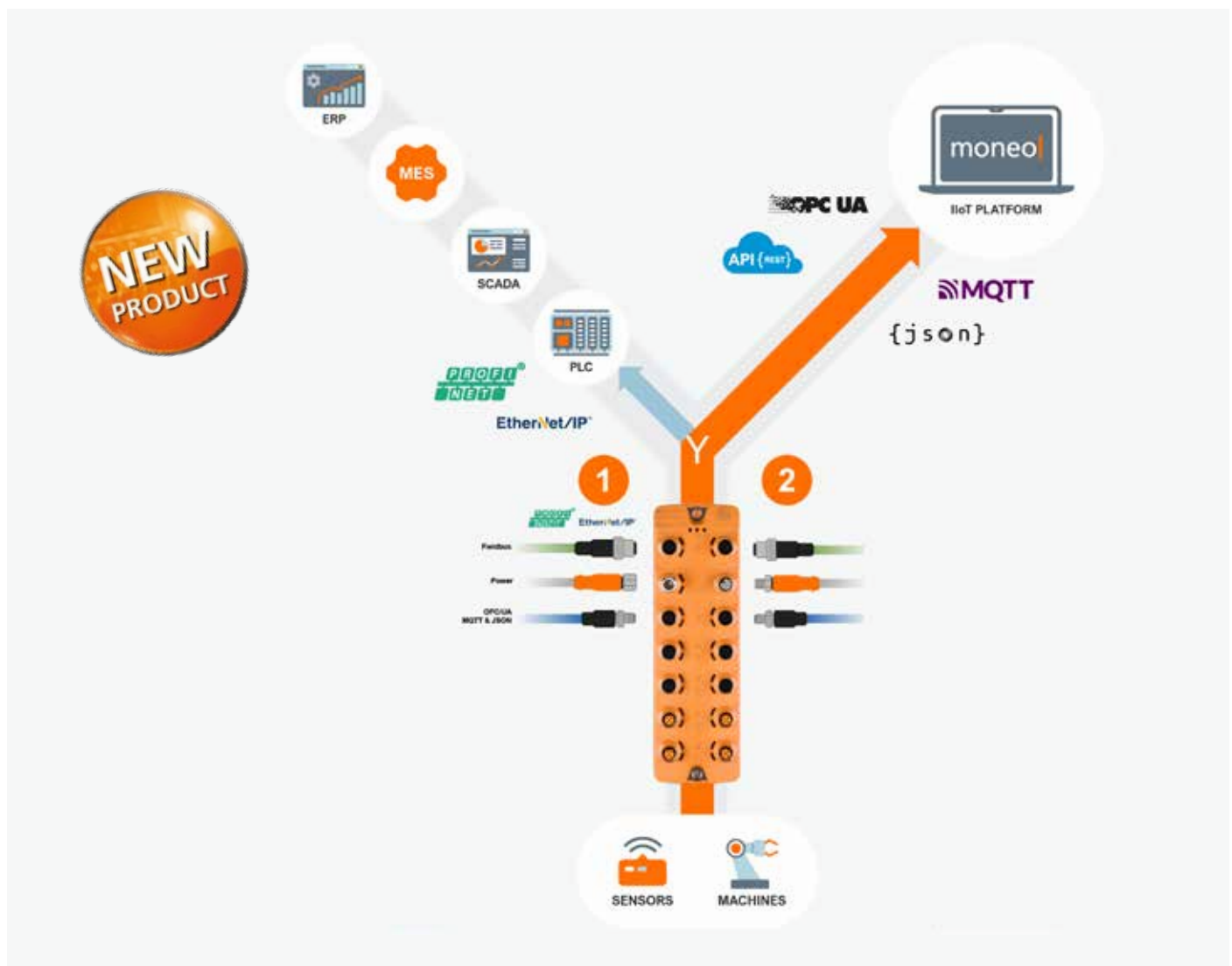

IO-Link System topology



Master option 1: SolutionBlock - Topology with IIoT

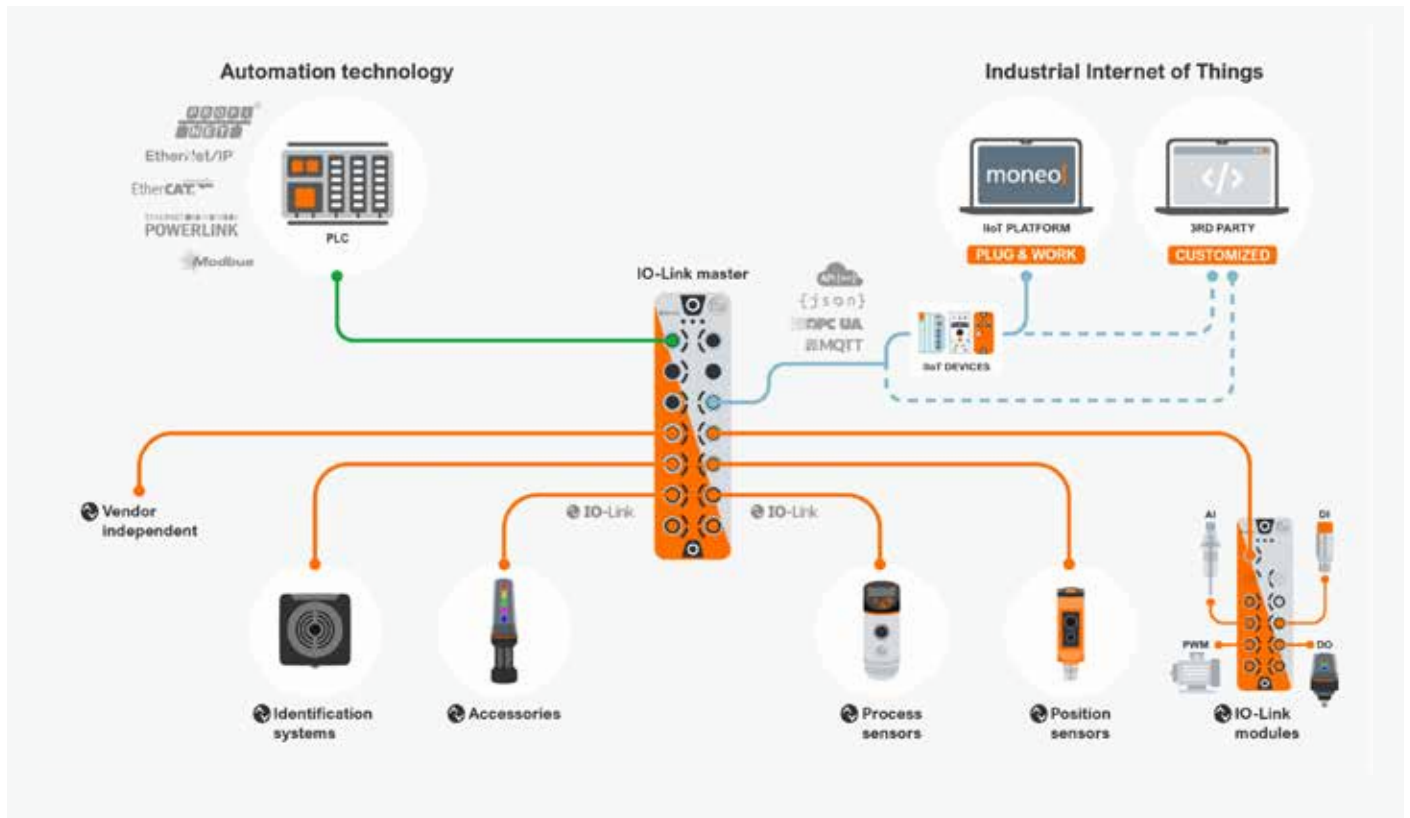

Master option 2: Standard-line

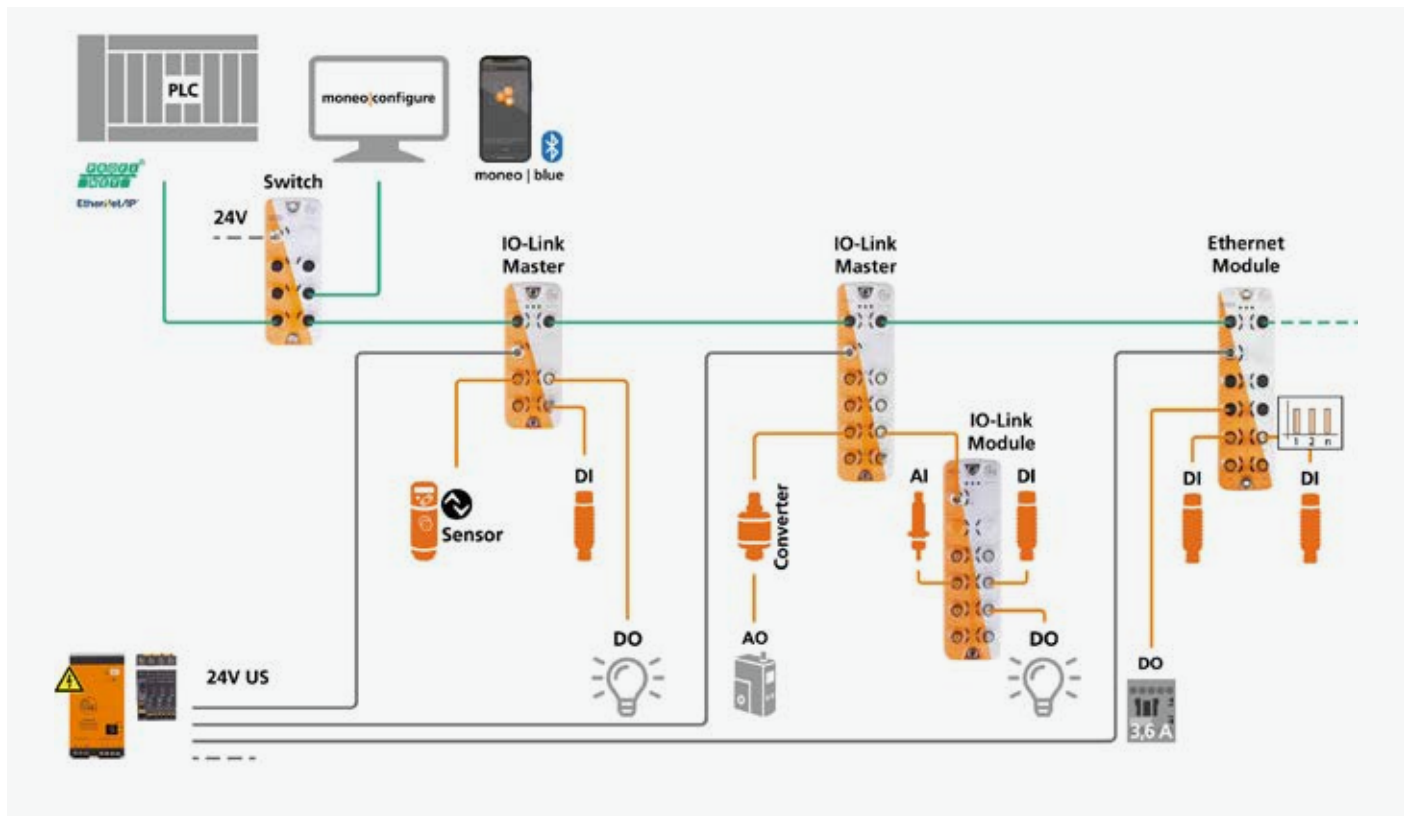

IO-Link System topology



Master option 3: Performance-line employ L-coded cable connectors for high current loads

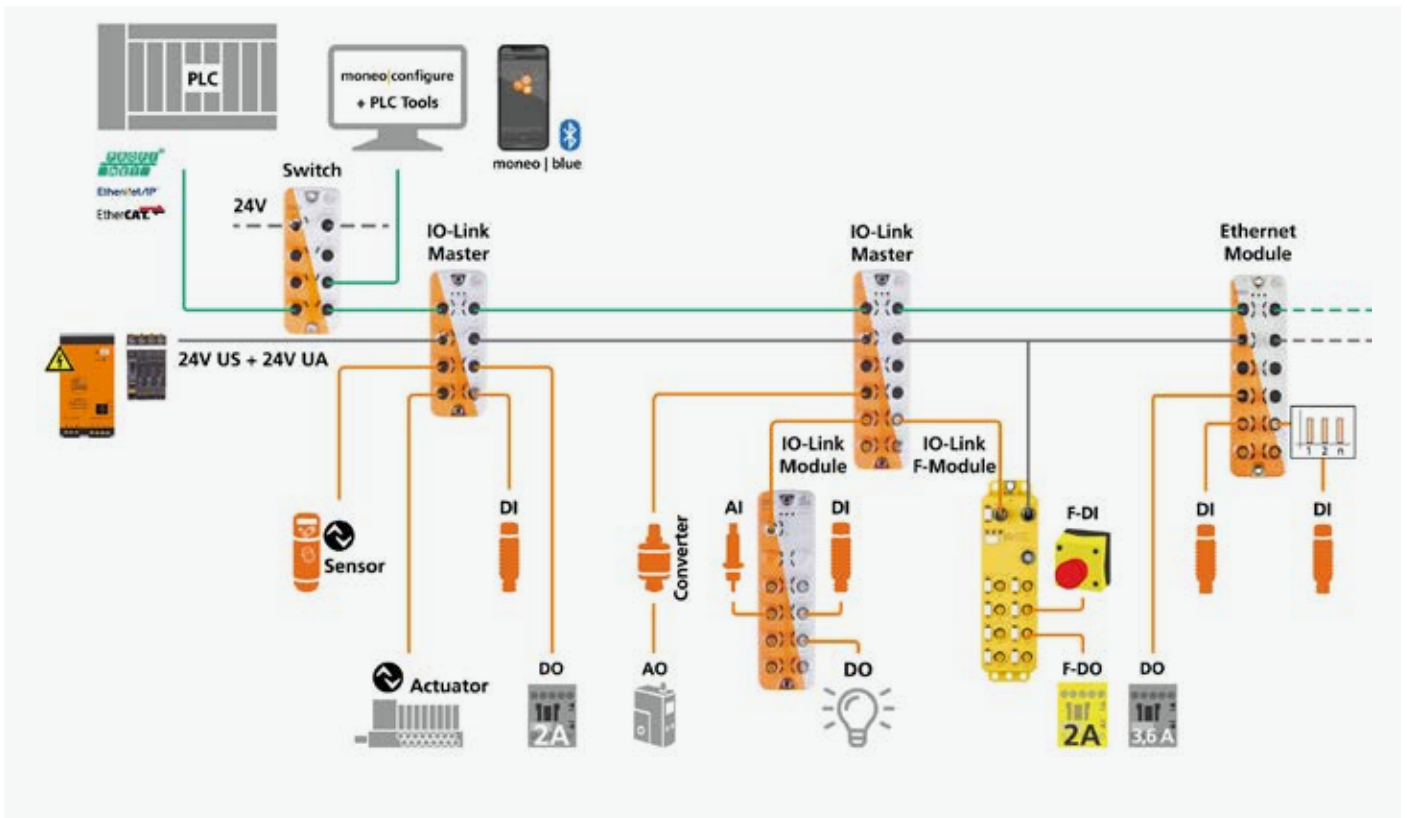

IO-Link system Application Report

Nelspray manufacture spraying solutions for the global panel-board industry. Their Systems feature advance flow and pressure control technology. High accuracy IO-link magnetic flow meters, pressure sensors with PLC control and IO-Link communication protocol to parameterise their sensors.





Type	Description	Order no.	Price	Order no.	Price
IO-Link Master - CabinetLine					
	Profinet + IoT 8-ports	AL1901	\$1,062.00	AL1900	\$1,094.00
	EtherNet/IP + IoT 8 ports	AL1921	\$1,062.00	AL1920	\$1,094.00
	EtherCat + IoT 8 ports	-	-	AL1930	\$1,062.00
	Modbus TCP + IoT 8 ports	-	-	AL1940	\$1,062.00
	PowerLink + IoT 8 ports	-	-	AL1970	\$1,062.00
	IoT only 8 ports	-	-	AL1950	\$1,033.00
IO-Link Master - Data Line (MQTT, JSON)					
	Profinet + IoT 8-ports	AL1306	\$901.00	AL1302	\$914.00
	EtherNet/IP + IoT 8-ports	AL1326	\$901.00	AL1322	\$914.00
	EtherCat + IoT 8-ports	-	-	AL1332	\$901.00
	Modbus TCP + IoT 8-ports	-	-	AL1342	\$901.00
	Profinet + IoT 4-ports	AL1304	\$771.00	AL1300	\$783.00
	EtherNet/IP + IoT 4-ports	AL1324	\$771.00	AL1320	\$783.00
	EtherCat + IoT 4-ports	-	-	AL1330	\$771.00
	Modbus TCP + IoT 4-ports	-	-	AL1340	\$771.00
IO-Link Master - SolutionBlock with OPC UA server - L coded, 16A, 12 DI / 12 DO, daisy chain option					
	Multiprotocol with PROFINET and EtherNet/IP Direct data transfer to on-premises IT levels via OPC UA Integrated IODD interpreter converts sensor data into readable information			AL1590	\$1,237.00
IO-Link Master - Standard Line					
	Profinet 4-port	-	-	AL1100	\$745.00
	EtherNet/IP 4-port	-	-	AL1120	\$745.00
	Profinet 8-port	-	-	AL1102	\$868.00
	EtherNet/IP 8-port	-	-	AL1122	\$868.00
IO-Link Configurable Multi-port modules					
	DI, 0...10V, 4...20mA*	DO 1...16*	AL2605	\$902.00	
	DI, 0...10V, 4...20mA* (A-port)	DO 1...16*	AL2301	\$732.00	
	DI 1...16*	DO 1...16*	AL2325	\$683.00	
	DI 1...16*	DO 1...16*	AL2321	\$669.00	
	6x2 DO M12 IP67	DO 12: (6x2)	AL2330	\$506.00	
	DI 12: (6x2)		AL2340	\$353.00	
	DI 20: (10x2)		AL2341	\$592.00	
	16 digital input/output cabinet module		AL5121	\$256.10	
Ethernet 6 Port Switches (unmanaged)					
	For Profinet networks		AL3000	\$613.00	
	TCP/IP networks; for EtherNet/IP networks; for Modbus TCP networks		AL3050	\$613.00	
Passive power distributor					
	Splitter Box 4SB IP67		AC5050	\$180.00	
	Splitter Box 8SB IP67		AC2951	\$258.00	

IO-Link System Components





IO-Link Configurable Multi-port modules



The AL5021 is designed to fit straight into many customary button housings, allowing connection of the control and signalling devices.

For small button housings, the AL5021 module can be mounted outside in the cable path. The potted plastic housing provides a high protection rating IP67.



Type	Inputs	Outputs	Order no.	Price
L-coded 16A Power distributor				
	Voltage distribution with standardised, L-coded M12 connection technology, robust potted design		EBC171	\$287.00
IO-Link temperature module				
	IO-Link Module, 4 x temperature sensor inputs including PT100, PT1000, thermocouple, IP67K		AL2384	\$485.00
Controller pneumatics using IO-Link air-boxes				
	2 x 3/2-way valve		AL5228	\$699.00
	1 x 5/2-way valve, monostable		AL5246	\$580.00
	1 x 5/2-way, valve, bi-stable		AL5251	\$792.00
	1 x 5/3-way valve, blocked middle position		AL5270	\$875.00
IO-Link input/output module				
	Number of parameterisable digital inputs / outputs: 16		AL5021	\$282.00



Industrial safety



Type	Description	Order no.	Price
PROFIsafe module			
	PROFIsafe 8 port module. Using "PROFIsafe" transmission protocol, safety sensors and actuators can now be operated via IO-Link. When connected to a PROFIsafe IO-Link Master. Features 8x safe digital inputs (OSSD) and 4x safe outputs. The PROFIsafe transmission telegram ensures a "tunneled" connection with the safety controller within the normal IO-Link communication. Complying to safety levels SIL 3 to IEC 61508 / EN 61508.	AL2005	\$1,750.00

Note: An Ethernet/IP safety master is in development by the IO-Link consortium.



Accessories

Type	Description	Order no.	Price
	M12 / RJ45 ethernet cables (refer to page p28)	-	-
	PROTECTIVE CAP M12 10PCS	E73004	\$14.00



Type	Description	Order no.	Price	Order no.	Price
IO-Link Master - Data Line (MQTT, JSON), IP69K					
	Profinet + IoT 8-ports	AL1307	\$1,028.00	AL1303	\$1,044.00
	EtherNet/IP + IoT 8-ports	AL1327	\$1,028.00	AL1323	\$1,044.00
	EtherCat + IoT 8-ports	-	-	AL1333	\$1,028.00
	Modbus TCP + IoT 8-ports	-	-	AL1343	\$1,028.00
	Profinet + IoT 4-port	AL1305	\$870.00	AL1301	\$883.00
	EtherNet/IP + IoT 4-ports	AL1325	\$870.00	AL1321	\$883.00
	EtherCat + IoT 4-ports	-	-	AL1331	\$870.00
	Modbus TCP + IoT 4-ports	-	-	AL1341	\$870.00
IO-Link Master - SolutionBlock with OPC UA server - L coded, 16A, 12 DI / 12 DO, daisy chain option					
	Multiprotocol with PROFINET and EtherNet/IP Direct data transfer to on-premises IT levels via OPC UA Integrated IODD interpreter converts sensor data into readable information	-	-	AL1591	\$1,369.00
IO-Link Master - Standard Line, IP69K					
	Profinet 4-port	-	-	AL1101	\$850.00
	Profinet 8-port	-	-	AL1103	\$1,002.00
	EtherNet/IP 4-port	-	-	AL1121	\$850.00
	EtherNet/IP 8-port	-	-	AL1123	\$1,002.00
IO-Link Master - Standard Line, IP69K					
	AS-i 4-port	-	-	AC6001	\$712.00
IO-Link Configurable Multi-port modules					
	DI, 0...10V, 4...20mA*	DO 1...16*	AL2205	\$888.00	
	DI, 0...10V, 4...20mA* (A-port)	DO 1...16*	AL2201	\$823.00	
	DI 1...16*	DO 1...16*	AL2225	\$778.00	
	DI 1...16*	DO 1...16*	AL2221	\$765.00	
	-	DO 12: (6x2)	AL2230	\$520.00	
	DI 12: (6x2)	-	AL2240	\$423.00	
	DI 20: (10x2)-	-	AL2241	\$691.00	
Ethernet 6 Port Switches (unmanaged)					
	For Profinet networks		AL3001	\$712.00	
	TCP/IP networks; for EtherNet/IP networks; for Modbus TCP networks		AL3051	\$712.00	
Passive power distributor					
	ProcessLine 4SB IP69K		AC2950	\$208.00	
	ProcessLine 8SB IP69K		AC2951	\$258.00	







Type	Inputs	Outputs	Order no.	Price
L-coded 16A Power distributor				
	Voltage distribution with standardised, L-coded M12 connection technology, robust potted design, IP69k protection		EBF017	\$320.00
IO-Link temperature module				
	IO-Link Module, 4 x temperature sensor inputs including PT100, PT1000, thermocouple, IP69K		AL2284	\$628.00





IO-Link Parameter setting software, moneo | configure free

With moneo configure, a large number of IO-Link devices and ifm IO-Link masters can be configured with just a few clicks. An integrated connection to the IODD database (online search function) also facilitates the integration of third-party devices. Convenient management of your own parameter data sets, including import and export functions, further accelerates the integration of new sensors.



Type	Description	Order no.	Price
	Moneo configure kit (includes the three parts below: AL1060, E12689, EVC012) moneo configure SA License	ZZ1060	\$633.00
	moneo configure SA License <ul style="list-style-type: none"> For all IO-Link devices and IO-Link masters Integrated, manufacturer-independent IODD management for time-saving sensor parameter setting. Cockpit for parallel display of parameters and process values. 	QMP010	\$310.00
	IO-Link Master USB 1P IP67	AL1060	\$599.00
	USB/M12 CABLE	E12689	\$50.00
	Connection cable	EVC012	\$49.00

Accessories

Type	Description	Order no.	Price
	Cables (refer to page 28)	-	-
	M12 316SS Protective caps (4 pieces per bag)	E12542	\$28.00
	Ethernet adapter M12 / RJ45	E21140	\$125.00
	Ethernet RJ45 connector	E12514	\$73.00

IO-Link Bluetooth communication

Monitor and configure IO-Link devices via Bluetooth adapter



- New IO-Link Bluetooth adapter allows access to sensors via smartphone*
- Easy parameter setting and reading of process values and events of all IO-Link devices connected to the master
- ifm moneo|blue available free of charge for iOS and Android
- Convenient parameter setting of many sensors thanks to graphic representation



FREE download via the app store!

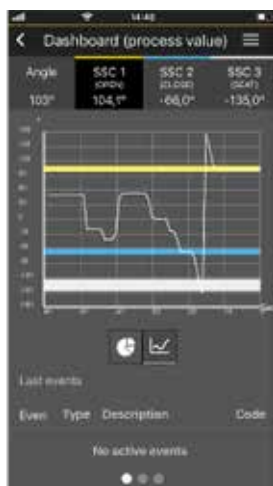

moneo|blue classic



<https://www.ifm.com/au/en/shared/productnews/2024/launch-09/bluetooth-mesh-system-for-easy-retrofitting>

IO-Link Master Sensor Value Display



Type	Description	Order no.	Price
128 x 128 resolution, 1.44" TFT LED display			
	IO-Link display · Connection to master · Assignment of the values displayed by the controller ·	E30391	\$303.00
	IO-Link inline display · Connection between master and sensor · Visualisation of the values of the connected sensor	E30430	\$357.00
	IO-Link display · Shows all sensor process values connected to a master	E30443	\$475.00

Type	Function	Input	Output	Industrial	Price	Wash-down	Price
				IP67		IP69K	
	Converter IO-Link » Analogue output	IO-Link	2x analog 4...20 mA	DP1213	\$354.00	DP3213	\$373.00
	Converter IO-Link » Analogue output	IO-Link	2x analog 0...10 V	DP1223	\$327.00	DP3223	\$348.00
	Converter Analogue » IO-Link	2x analog 0...10 V	IO-Link	DP1222	\$327.00	DP3222	\$348.00
	Relay-Adapter	2x digital PNP	2x Solid state relay normally open	DP1603	\$208.00	DP3603	\$242.00
	Relay-Adapter	2x digital PNP	2x solid state relay normally closed	DP1613	\$208.00	DP3613	\$242.00
	Speed monitor	1x digital PNP	2x digital PNP/NPN	DP2122	\$326.00	DP4122	\$316.00
	Converter Analogue » IO-Link	1x analog 4...20 mA	1x digital, 1x analog	DP2200	\$279.00	DP4200	\$270.00
	Counter	2x digital PNP	2x digital PNP/NPN	DP2302	\$332.00	DP4302	\$320.00
	Pulse extender	2x digital PNP	2x digital PNP	DP2402	\$292.00	DP4402	\$290.00
	IO-Link inline bluetooth adaptor	-	-	-	-	EIO330	\$347.00
	Bluetooth Mesh adapter	-	-	-	-	EIO344	\$337.00
	Bluetooth Mesh base station	-	-	-	-	EIO404	\$1,028.00

The possibilities of Bluetooth Mesh



Scan to learn more

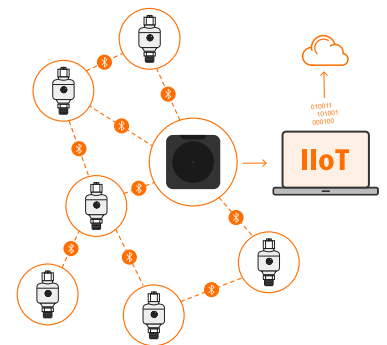

The Bluetooth Mesh system consists of up to 50 Bluetooth adapters that can be paired with a base station. The adapters are connected to IO-Link sensors (manufacturer-independent) and transmit the process data to the base station via Bluetooth. If the base is outside the range of an adapter, one or more adapters act as intermediaries and pass on the information. Using ifm's IoT Core and MQTT/JSON, the base transfers the sensor data to downstream IIoT systems.

Accessories







Type	Description	Order no.	Price
	Mounting Clip <ul style="list-style-type: none"> Reliable fixing of the IO-Link mini display Easy, quick and secure mounting Robust design for use in harsh industrial environments 	E89208	\$30.00
	IO-Link repeater <ul style="list-style-type: none"> Extension of IO-Link range up to 80 m Series connection of max. 3 repeaters possible 	E30444	\$500.00

Ethernet cables & power supplies



Industrial Ethernet D-code cable (fieldbus) Green, PUR / Ni PI brass Connectors

		Price		Price		Price		Price
	RJ45 - M12, 4-pole		RJ45 - M12, 4-pole		Jumper . M12/M12, 4-pole		Plug . M12 flying lead, 4-pole	
0.5 m	EVC924	\$41.00	EVC930	\$41.00	EVC904	\$40.00	-	-
1.0 m	-	-	-	-	EVC905	\$46.00	-	-
2.0 m	EVC926	\$58.00	EVC932	\$58.00	EVC906	\$57.00	EVC893	\$34.00
5 m	EVC927	\$89.00	EVC933	\$89.00	EVC907	\$89.00	EVC894	\$67.00
10 m	EVC928	\$144.00	EVC934	\$144.00	EVC908	\$144.00	EVC895	\$121.00
20 m	-	-	EVC935	\$251.00	EVC909	\$252.00	EVC896	\$229.00
50 m	-	-	-	-	-	-	EVC897	\$555.00

Washdown Ethernet D-code cable (fieldbus), Grey, MPPE, SS316L Connectors (Indoor F&B)

		Price		Price		Price		Price
	RJ45 - M12, 4-pole		RJ45 - M12, 4-pole		Jumper . M12/M12, 4-pole		Plug . M12 flying lead, 4-pole	
0.25 m	-	-	-	-	EVF528	\$55.00	-	-
0.5 m	EVF549	\$57.00	-	-	EVF529	\$58.00	-	-
1.0 m	EVF550	\$63.00	-	-	EVF530	\$64.00	-	-
2.0 m	EVF551	\$75.00	EVF557	\$73.00	EVF531	\$76.00	EVF518	\$50.00
5 m	EVF552	\$110.00	EVF558	\$106.00	EVF532	\$111.00	EVF519	\$85.00
10 m	EVF553	\$169.00	EVF559	\$163.00	EVF533	\$170.00	EVF520	\$144.00
20 m	EVF554	\$287.00	EVF560	\$276.00	EVF534	\$288.00	EVF521	\$263.00
50 m	-	-	-	-	-	-	EVF522	\$618.00

24V DC Switched mode power supplies - high efficiency, space saving



Learn more



Permanent output current / peak at 24 V	Input voltage [V AC]	Buffer time (120/230 V AC) [ms]	Order no.	Price
24 V DC switched-mode power supplies for control cabinet installation				
1.25 A	100...240	-	DN1030	\$230.00
2.5 A	100...240	-	DN1031	\$273.00
3.3 A / 3.3 A	100...240	30 / 128	DN4011	\$349.00
5 A / 6 A	100...240	80 / 78	DN4012	\$462.00
10 A / 12 A	100...240	46 / 47	DN4013	\$604.00
20 A / 24 A	100...240	26 / 26	DN4014	\$788.00
5 A / 6 A	2 x 380...480	27 / 48	DN4032	\$538.00
10 A / 12 A	3 x 380...480	34 / 54	DN4033	\$643.00
20 A / 30 A	3 x 380...480	22 / 22	DN4034	\$861.00
40 A / 60 A	100...240	27 / 27	E84016	\$1,418.00
40 A / 60 A	3 x 380...480	-	E84036	\$1,241.00
24 V DC switched-mode power supplies for FIELD MOUNTING IP67				
8 A, 1 PH	100...240	44 / 44	DN4217	\$1,025.00
12 A, 1 PH	100...240	44 / 44	DN4218	\$1,622.00
20 A, 3 PH	400...480	24 / 24	DN4234	\$1,686.00
20 A, 3 PH	400...480	24 / 24	DN4237	\$1,797.00

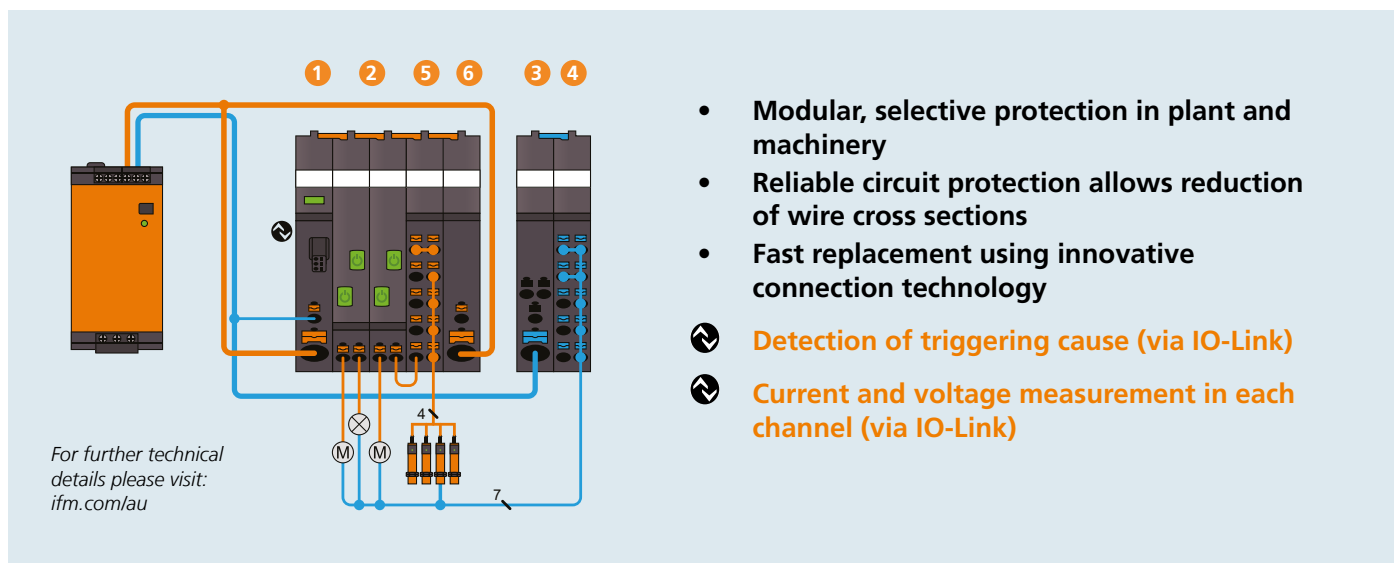

- Modular, selective protection in plant and machinery
- Reliable circuit protection allows reduction of wire cross sections
- Fast replacement using innovative connection technology
- Detection of triggering cause (via IO-Link)
- Current and voltage measurement in each channel (via IO-Link)

Modular installation

The system has a modular structure and consists of a supply module to feed max. 40 A. The protection modules can be mounted side by side. This is done via a simple clip mechanism, completely without any bridges, jumpers or the like. Potential modules are used to distribute the circuits and wire the ground lead. Easy mounting and minimised wiring complexity save cost and time. With the standard version the user can connect up to 10 and with the IO-Link version up to 8 safety modules to the head module.

Ground modules: BEFORE



Ground modules: AFTER



	Inputs [V DC]	Nominal current [A]	Order no.	Price	Order no.	Price
1	Supply modules		IO-Link		Standard	
	24, 40 A	–	DF2101	\$170.00	DF1100	\$70.00
2	Protection modules		IO-Link		Standard	
	–2 x 2		DF2212	\$141.00	DF1212	\$125.00
	–	2 x 4	DF2214	\$141.00	DF1214	\$125.00
	–	2 x 6	DF2216	\$141.00	DF1216	\$125.00
	–	1 x 8	DF2208	\$123.00	DF1208	\$110.00
	–	1 x 10	DF2210	\$123.00	DF1210	\$110.00
	–	2 x 1...10	DF2220	\$161.00	DF1220	\$148.00
GND and load modules						
3	Feed module GND, 1 x 10 mm ²		–	DF3100	\$29.00	
4	Potential module GND, 10 x 2,5 mm ²		–	DF3110	\$71.00	
5	Potential module LOAD 2 x 5 x 2,5 mm ²		–	DF3200	\$78.00	
6	Feed module		–	DF3210	\$57.00	

Accessories

Type	Description	Order no.	Price
	IO-Link connection cable, 0,5 m, M12 connector	E12613	\$60.00
	IO-Link connection cable, 2 m, open end	E12614	\$60.00

IO-Link System - edge gateways

Field programmable logic controller for industrial environments



Free up electrical cabinet space while improving ergonomics for operators

Example controls architecture

- HMI Controller
- 16 IO-Link Masters
- 90 IO-Link Inputs
- 38 Digital Outputs
- CODESYS V3.5 Software
- IIoT Software Connectors

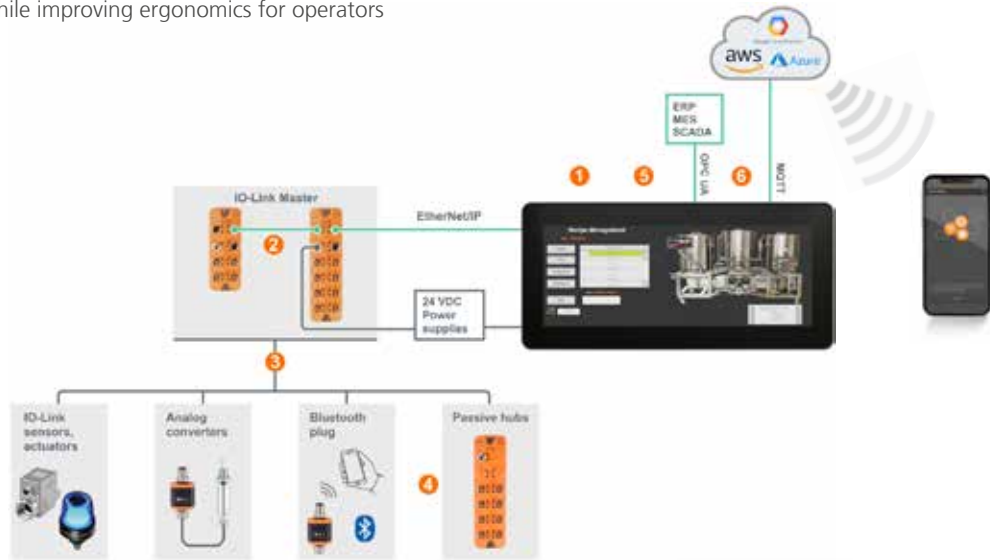

For more insights:



Panel programmable logic controller

Robust 2 in 1 cloud connector and powerful controller, refer page 21

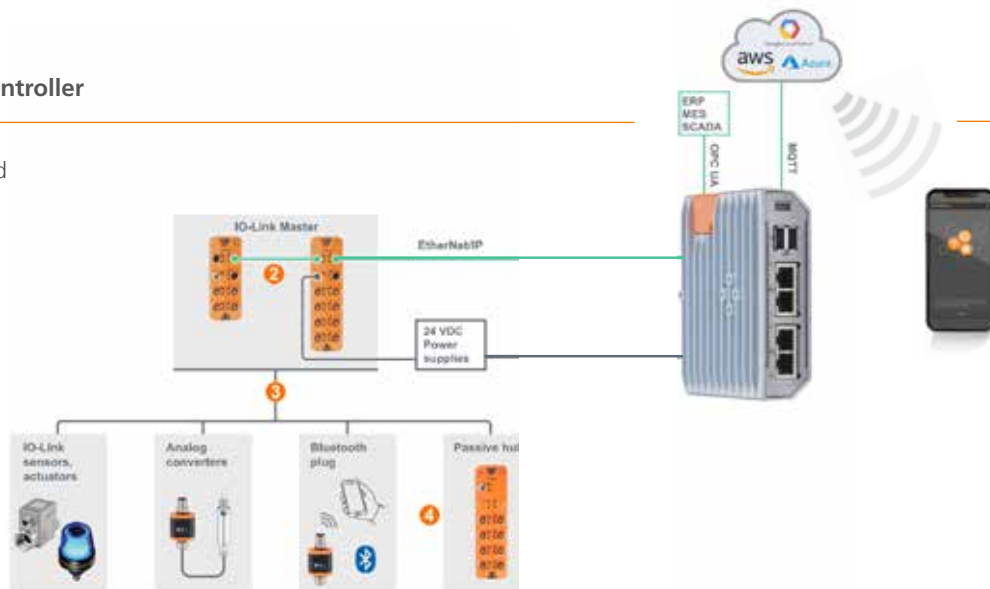

CODESYS software for I4.0 industrial controls

Easy to use software for application programming and configuration setting



Fully functional PLC with integrated HMI



LED displays with optical bonding	Order No.				
	CR1152	CR1077	CR1102	CR1204	CR1203
Display	5.0"	7.0"	10.0"	12.0"	12.3"
Prices	\$3,061.00	\$4,844.00	\$5,304.00	\$6,082.00	\$6,089.00
Aspect ratio	16:10	16:10	16:10	16:10	8:3
Resolution	800 x 480	800 x 480	1280 x 800	1280 x 800	1280 x 480
Colour depth	24 bit	18 bit	24 bit	24 bit	24 bit
Touch	•	•	•	•	•
Controller with GPU	dual core, 800 Mhz	quad core, 1.2 GHz	ARM Quad Core 64 Bit, 1.2 GHz	ARM Quad Core 64 Bit, 1.2 GHz	quad core, 1.2 GHz
Memory (RAM) [GByte]	1	1	1	1	1
Memory (flash) [GByte]	4	8	8	8	8
Buttons (RGB backlit)	4	6	8	10	-
Navigation element	cross	cross	cross	cross	-
COMMUNICATION INTERFACE					
Ethernet CAN	1	2	2	2	2
USB 2.0	4	4	4	4	4
	1	2	2	2	2
Analogue video interfaces	2	4	4	4	4
AUDIO INTERFACES					
Stereo Out (amplified)	1	1	1	1	1
Line In	-	1	1	1	1
Headphones Out	-	1	1	1	1
INPUTS / OUTPUTS					
Digital In BL	2	2	2	2	2
Digital Out 2.5 A	2	2	2	2	2

Powerful, versatile cabinet or field programmable logic controllers



- 2-in-1: cloud connector and powerful controller
- Perfect IO-Link integration
- Plug & Work access to the I/O level via Ethernet
- Can be mounted on a DIN rail or in the field for the IP67 version
- CODESYS 3.5

Description - IloT Controller for use in the field or in a control cabinet	Order no.	Price
IloT Controller IP20 1S. Communication interface Ethernet; USB, Number of Ethernet interfaces 4, Number of USB interfaces 2"	AE3100	\$1,485.00
IloT Controller IP67. Communication interface Ethernet, Number of Ethernet interfaces 4, Number of USB interfaces 2"	AE3400	\$1,808.00

Moneo: IIoT platform for industry and production

A new approach to collecting sensor data

Before

Machine availability: ?

Energy consumption: ?

Process quality: ?

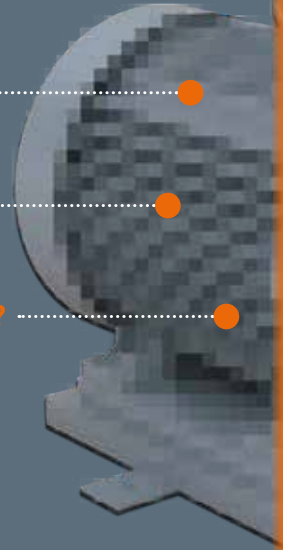

Do you know when your engine will fail?

With moneo you know! Prevent unplanned downtime by predicting failures and increasing your **machine availability**.



Predictability

Your operating resources are available as planned.



Self-monitoring

Your production systems automatically detect and report quality defects.



Process stability

Your cycle times are not affected by damaged machines.

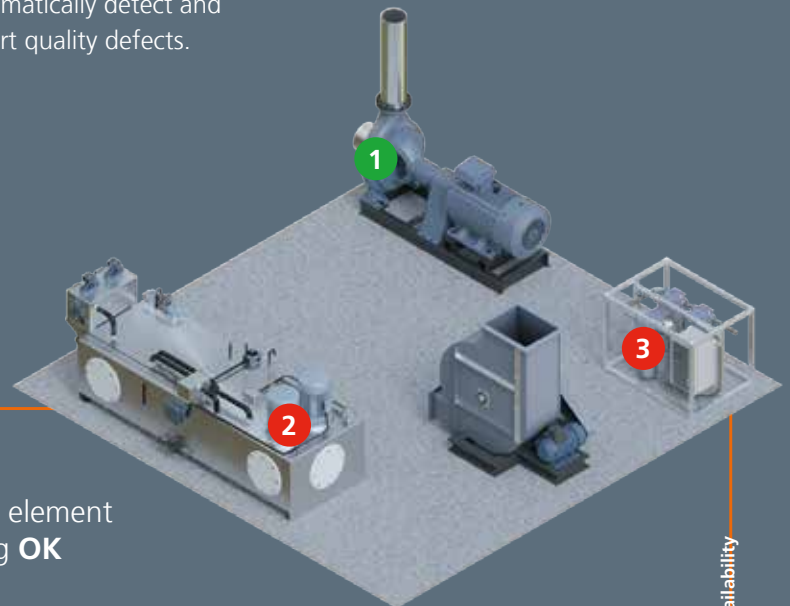

1 Rolling element bearing **OK**

2 Pressure loss: **oil leakage**

3 Filter service life **ends** in 7 days

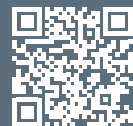

ifm.com/cnt/moneo-availability





Learn more

After

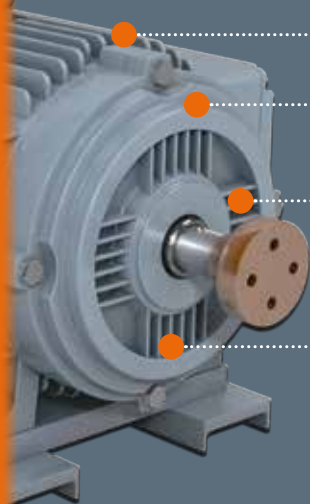

Operating hours: 8324 h

Temperature
very high: 105 C°

Energy consumption:
rising power
consumption

Warning:
bearing damage detected

How many product recalls can you afford?

If a quality problem goes unnoticed, it can jeopardise entire batches – or trigger a recall. With moneo, you can detect deviations in real time and intervene immediately. While reducing rejects and avoiding costly errors, this enables you to ensure **product quality** based on data.



1 Change the IBC in WAREHOUSE B

2 Tank level **low**: 5 % capacity

3 CIP process temperature: **OK**



ifm.com/cnt/moneo-quality



Detecting process deviations

Monitor deviations in real time to avoid rejects, reworking and product recalls.



Ensuring product safety

Monitor critical components by using intelligent sensors and visualisation software.



Meeting customer requirements

Ensure the highest quality standards to exceed customer expectations.

moneo IIoT platform

Start small, validate value,
scale with confidence



Learn more



1

Description	Order no.	Price
edgeGateway for connecting the production environment to the IIoT platform moneo		
RJ45, IIoT edgeGateway IP20 15	AE2100	\$1,830.00
IIoT edgeGateway IP67	AE2400	\$2,147.00
io-key Cellular IoT Gateway IOL 2P WW, bluetooth	AIK050	\$891.00

Cloud subscription for moneo info points

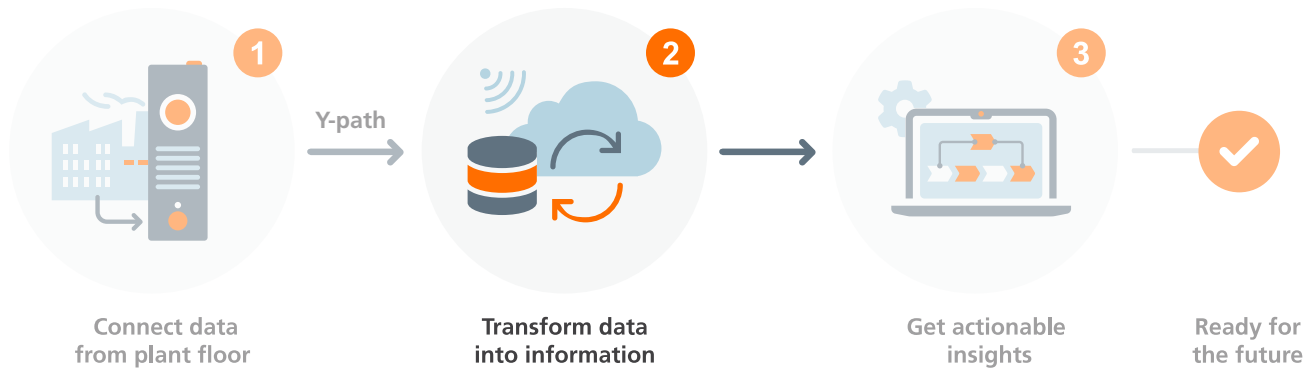

Software description (minimum subscription 1 year)	Order no.	Annual subscription
Cloud subscription (500 INFO POINTS) for the IIoT platform to digitise production processes		
<ul style="list-style-type: none"> • Software-as-a-Service (SaaS) model operated by ifm to enable multi-site, cloud-based working without IT involvement • Using the potential of data from the machines in production and converting it into valuable information • Predicting failures, preventing standstills and thus increasing machine availability • Visualising or analysing production processes and monitoring deviations in real time • Reducing operating cost by monitoring the energy consumption at machine level 	QCM100	\$3,600.00
Cloud subscription (100 INFO POINTS) for the no-code IIoT platform.		
<ul style="list-style-type: none"> • Using the potential of data from the machines in production and converting it into valuable information • Predicting failures, preventing standstills and thus increasing machine availability • Visualising or analysing production processes and monitoring deviations in real time • Reducing operating cost by monitoring the energy consumption at machine level • Save, visualise and access data across locations in one system without IT involvement 	QCM110	\$960.00
Cloud subscription for 100 EXTRA info points		
<ul style="list-style-type: none"> • IIoT licence for the use of info points in moneo • Customisation of data streams depending on the application • Flexible access to functions and value-added services • Can be used cross-module in moneo • Expandable at any time 	QCM001	\$720.00

* Note: minimum subscription is one year.



moneo | – no-code IIoT platform
Seamlessly collect, visualise and monitor sensor data to

Improve machine availability

Maintain process quality

Optimise energy consumption

Configure devices

Device management

Calculated values

edgeConnect

Dashboard

Analysis

Tasks and tickets

remoteConnect

Cloud add-on subscription for moneo IIoT Core

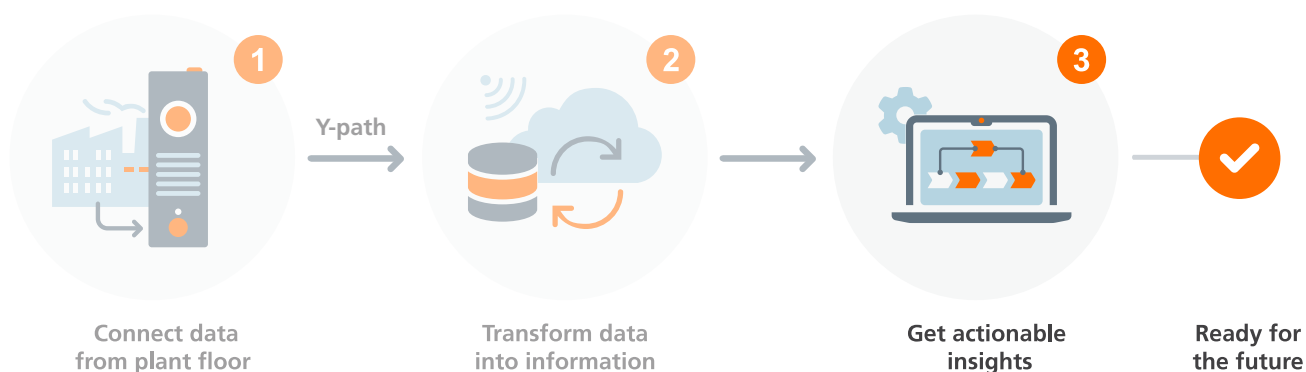

Software description (minimum subscription 1 year)	Order no.	Annual subscription
cloud add-on subscription for moneo IIoT Core		
<ul style="list-style-type: none"> Generating knowledge from information with the Industrial AI Assistant and Track & Trace Automatically generating data-driven, meaningful and actionable insights to increase efficiency Increasing transparency of goods flows in production and (intra-)logistics Increasing system availability and production process sustainability Creating individual AI-supported production monitoring without any programming knowledge 	QCM500	\$1,200.00

Application report: Continuous radar level measurement of CIP tanks, using moneo



The non-contact level measurement principle with radar offers many advantages for monitoring a CIP system. Contact with media (acids, alkalis) and heating coils is avoided so that the measurement is independent of the temperature and density of the media. These advantages complete the quality assurance of the CIP cleaning process.

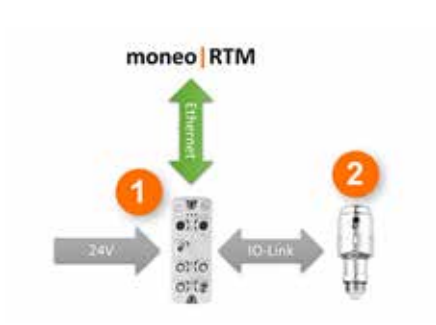

IO-Link master (e.g. \$837.00)
1 \$3,194.00 level sensor \$3,194.00



Level in metres
Volume in litres



ifm connection technology



Learn more



Note: refer to ifm product datasheet for operating voltage range and max. current load data!



Technology

Select the right connector for your application!



EVC series black PUR rubber, Halogen-free, nickel-plated brass nut. Designed for industrial applications, esp. where cables contact oil/grease.



EVT series orange PVC, SS316L nut. Designed F&B industry use, where cables contact water & plant washdown cleaning chemicals



EVF series grey MPPE, Halogen-free, SS316L grip nut. Designed F&B industry use, where cables contact water & plant washdown cleaning chemicals (avoid outdoor UV exposure)



EVM series black PUR rubber, Halogen-free, SS316L nut. Designed for harsh environments, ie. mobile machines, -40degC. Refrigeration, Outdoor UV exposure.



EVC D-Coded ethernet connectors Green PUR rubber, Halogen-free, nickel-plated brass nut. Designed for industrial applications, esp. where cables contact oil/grease



EVF D-Coded ethernet connectors grey MPPE, Halogen-free, SS316L grip nut. Designed F&B industry use, where cables contact water & plant washdown cleaning chemicals (avoid outdoor UV exposure)



L Coded connectors

2.5 mm² cable cross section for currents up to 16 amperes

EVC series black PUR rubber for industrial applications

EVF series grey MPPE for F&B washdown applications



CAN bus connectors PUR rubber

EVC, Halogen-free, SS316L nut. Designed for harsh environments, ie. mobile machines, -40degC. Refrigeration, Outdoor UV exposure



Correct application ensures IP rating success!

Advantages of ifm ecolink

- Optimum sealing even when fastened by hand.
- The mechanical end stop protects the O-ring against destruction.
- Nut secured against shock and vibration due to saw tooth contoured vibration protection.
- LEDs clearly visible even in cases of high light exposure.

Ingress-resistant:

The innovative sealing concept provides the high protection ratings IP 67 / IP 68 / IP 69K.

Held in place:

The saw-tooth type vibration protection ensures that the nut does not become loose unintentionally in case of shock and vibration.

By hand:

Easy to install and remove manually.

Visible:

Versions in a transparent black housing for an optimum visibility of the LED even in bright lighting conditions.

Standardised:

The connection technology meets the M8 and M12 standard EN 61076.

Versatile:

Special versions adapted to your application.

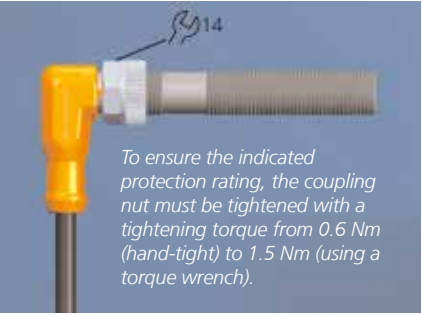

To ensure the indicated protection rating, the coupling nut must be tightened with a tightening torque from 0.6 Nm (hand-tight) to 1.5 Nm (using a torque wrench).

"Lock-in-Place" coupling nut secures the cordset to a quick disconnect sensor and resists high levels of shock and vibration.

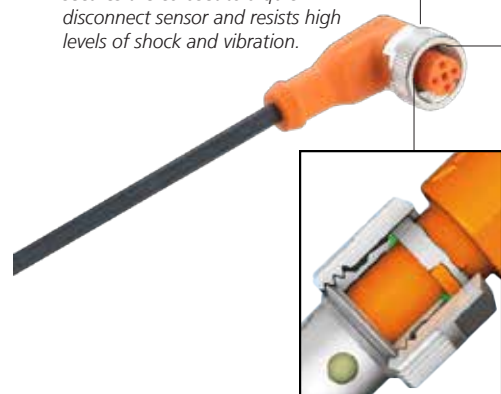

316 stainless steel sleeve with sawtooth contour maintains optimum sealing and prevents the cordset from detaching.

Special insert design acts as a mechanical end stop preventing possible damage to Viton o-ring from over tightening.

 Problem Traditional cordsets with transparent housings are hard to see.	 Solution ifm cordsets have high visibility LEDs with good contrast.
---	--

Tested to extremes.
The temperature shock test simulates CIP processes and verifies the ageing resistance.



An eye on the plant process.
Even in bright lighting conditions the LEDs are clearly visible in the transparent black version.



Easy mounting without using a tool.

Vibration protection with end stop.
The saw-tooth type vibration protection ensures that the nut does not become loose unintentionally in case of shock and vibration.





Angled M12 Socket, 4pin, IP69K, 4 Amp (max)

Wiring	EVC		EVT		EVF		EVM	
	EVC Industrial	Price	EVT F&B	Price	EVF F&B	Price	EVM Outdoor	Price
	Black, TPU		Orange, PVC		Grey, MPPE		Black, TPU	
	Ni Pl brass		SS 316 L		SS 316 L		SS 316 L	
2 m	EVC004	\$35.00	EVT067	\$41.00	EVF067	\$50.00	EVM004	\$45.00
5 m	EVC005	\$41.00	EVT004	\$46.00	EVF004	\$51.00	EVM005	\$52.00
10 m	EVC006	\$50.00	EVT005	\$57.00	EVF005	\$63.00	EVM006	\$62.00
15 m	EVC086	\$72.00	EVT094	\$64.00	EVF094	\$78.00	EVM019	\$72.00
20 m	EVC087	\$84.00	EVT095	\$75.00	EVF095	\$90.00	-	-
25 m	EVC088	\$89.00	EVT006	\$89.00	EVF006	\$99.00	EVM012	\$97.00
40 m	-	-	EVT066	\$121.00	-	-	-	-
50 m	EVC715	\$149.00	-	-	EVF479	\$172.00	EVM010	\$157.00
60 m	-	-	EVT068	\$164.00	-	-	-	-

Straight M12 Socket, 4pin, IP69K, 4 Amp (max)

Wiring	EVC		EVT		EVF		EVM	
	EVC Industrial	Price	EVT F&B	Price	EVF F&B	Price	EVM Outdoor	Price
	Black, TPU		Orange, PVC		Grey, MPPE		Black, TPU	
	Ni Pl brass		SS 316 L		SS 316 L		SS 316 L	
2 m	EVC001	\$35.00	EVT064	\$41.00	EVF064	\$50.00	EVM001	\$45.00
5 m	EVC002	\$41.00	EVT001	\$46.00	EVF001	\$51.00	EVM002	\$52.00
10 m	EVC003	\$50.00	EVT002	\$57.00	EVF002	\$63.00	EVM003	\$62.00
15 m	EVC082	\$72.00	EVT092	\$64.00	EVF092	\$82.00	EVM018	\$72.00
20 m	EVC083	\$84.00	EVT093	\$75.00	-	-	-	-
25 m	EVC084	\$89.00	EVT003	\$89.00	EVF003	\$99.00	EVM014	\$97.00
40 m	EVC759	\$122.00	EVT418	\$121.00	-	-	-	-
50 m	EVC710	\$149.00	-	-	EVF484	\$200.00	-	-
60 m	-	-	EVT343	\$164.00	-	-	EVM065	\$187.00
70 m	-	-	EVT438	\$237.00	-	-	-	-

Angled M12 Socket, 5pin, IP69K, 4 Amp (max)

Wiring	EVC		EVT		EVF		EVM	
	EVC Industrial	Price	EVT F&B	Price	EVF F&B	Price	EVM Outdoor	Price
	Black, TPU		Orange, PVC		Grey, MPPE		Black, TPU	
	Ni Pl brass		SS 316 L		SS 316 L		SS 316 L	
2 m	EVC073	\$38.00	EVT603	\$44.00	-	-	EVM039	\$47.00
5 m	EVC074	\$47.00	EVT013	\$52.00	EVF013	\$59.00	EVM040	\$58.00
10 m	EVC075	\$64.00	EVT014	\$69.00	EVF014	\$78.00	EVM041	\$77.00
15 m	EVC423	\$72.00	EVT104	\$86.00	-	-	-	-
25 m	-	-	EVT015	\$121.00	EVF015	\$137.00	-	-



Straight M12 Socket, 5pin, IP69K, 4 Amp (max)

Wiring	EVC		EVT		EVF		EVM	
	EVC Industrial	Price	EVT F&B	Price	EVF F&B	Price	EVM Outdoor	Price
	Black, TPU		Orange, PVC		Grey, MPPE		Black, TPU	
	Ni PI brass		SS 316 L		SS 316 L		SS 316 L	
2 m	EVC070	\$38.00	EVT235	\$47.00	-	-	EVM036	\$47.00
5 m	EVC071	\$47.00	EVT010	\$52.00	EVF010	\$59.00	EVM037	\$58.00
10 m	EVC072	\$64.00	EVT011	\$69.00	EVF011	\$78.00	EVM038	\$77.00
15 m	EVC197	\$72.00	EVT419	\$86.00	-	-	EVM083	\$96.00
20 m	EVC198	\$86.00	-	-	-	-	-	-
25 m	EVC199	\$98.00	EVT012	\$121.00	EVF012	\$137.00	EVM112	\$142.00
30 m	EVC561	\$195.00	-	-	-	-	-	-
40 m	-	-	EVT420	\$163.00	-	-	-	-
50 m	EVC562	\$325.00	-	-	-	-	-	-
60 m	EVC591	\$389.00	-	-	-	-	-	-

Straight M12 Plug, Straight M12 Plug, 4pin, IP69K, 4 Amp (max)

Wiring	EVC		EVT		EVF	
	EVC Industrial	Price	EVT F&B	Price	EVF F&B	Price
	Black, TPU		Orange, PVC		Grey, MPPE	
	Ni PI brass		SS 316 L		SS 316 L	
1m	EVC556	\$34.00	-	-	-	-
2 m	EVC076	\$31.00	EVT071	\$45.00	EVF071	\$49.00
5 m	EVC077	\$40.00	EVT072	\$51.00	EVF072	\$57.00
10 m	EVC078	\$60.00	EVT073	\$60.00	EVF073	\$75.00
20 m	EVC177	\$83.00	-	-	-	-
25 m	-	-	EVT350	\$87.00	-	-

Angled M12 Plug, Straight M12 Plug, 4pin, IP69K, 4 Amp (max)

Wiring	EVC		EVT		EVF	
	EVC Industrial	Price	EVT F&B	Price	EVF F&B	Price
	Black, TPU		Orange, PVC		Grey, MPPE	
	Ni PI brass		SS 316 L		SS 316 L	
2 m	EVC079	\$31.00	EVT088	\$45.00	EVF088	\$50.00
5 m	EVC080	\$40.00	EVT090	\$51.00	EVF090	\$57.00
10 m	EVC081	\$60.00	EVT327	\$57.00	EVF327	\$62.00
15 m	EVC185	\$64.00	-	-	EVF726	\$68.00
20 m	EVC172	\$84.00	-	-	EVF727	\$75.00
25 m	EVCA05	\$102.00	-	-	-	-



Wirable - Industrial M12.Sockets & M12.Plugs, 4pin, IP69K, 4 Amp (max)

<p>Wiring</p>								
	EVC Industrial	Price	EVC Industrial	Price	EVC Industrial	Price	EVC Industrial	Price
Cable Material	Orange, PA		Orange, PA		Orange, PA		Orange, PA	
Nut Material	Ni PI brass		Ni PI brass		Ni PI brass		Ni PI brass	
-	EVC810	\$37.00	EVC811	\$37.00	EVC812	\$37.00	EVC813	\$37.00

Wirable - Industrial M12.Sockets & M12.Plugs, 5pin, IP69K, 4 Amp (max)

<p>Wiring</p>								
	EVC Industrial	Price	EVC Industrial	Price	EVC Industrial	Price	EVC Industrial	Price
Cable Material	Orange, PA		Orange, PA		Orange, PA		Orange, PA	
Nut Material	Ni PI brass		Ni PI brass		Ni PI brass		Ni PI brass	
-	EVC814	\$40.00	EVC815	\$40.00	EVC816	\$40.00	EVC817	\$40.00

Wirable - Washdown M12.Sockets & M12.Plugs, 4pin, IP69K, 4 Amp (max)

<p>Wiring</p>								
	EVF F&B	Price	EVF F&B	Price	EVF F&B	Price	EVF F&B	Price
Cable Material	Grey, PA		Grey, PA		Grey, PA		Grey, PA	
Nut Material	SS316L		SS316L		SS316L		SS316L	
-	EVF565	\$56.00	EVF566	\$56.00	EVF567	\$56.00	EVF568	\$56.00

Wirable - Washdown M12.Sockets & M12.Plugs, 5pin, IP69K, 4 Amp (max)

<p>Wiring</p>								
	EVF F&B	Price	EVF F&B	Price	EVF F&B	Price	EVF F&B	Price
Cable Material	Grey, PA		Grey, PA		Grey, PA		Grey, PA	
Nut Material	SS316L		SS316L		SS316L		SS316L	
-	EVF569	\$60.00	EVF570	\$60.00	EVF571	\$60.00	EVF572	\$60.00



Jumper, Straight M12 Socket, Straight M12 Plug, 4pin, IP69K, 4 Amp (max)

Wiring	EVC		EVT		EVF		EVM	
	EVC Industrial	Price	EVT F&B	Price	EVF F&B	Price	EVM Outdoor	Price
	Black, TPU		Orange, PVC		Grey, MPPE		Black, TPU	
	Ni Pl brass		SS 316 L		SS 316 L		SS 316 L	
0.3 m	EVC010	\$46.00	EVT040	\$71.00	EVF040	\$83.00	-	-
0.6 m	EVC011	\$48.00	EVT041	\$73.00	EVF041	\$84.00	-	-
1 m	EVC012	\$49.00	EVT042	\$78.00	EVF042	\$90.00	-	-
2 m	EVC013	\$52.00	EVT043	\$79.00	EVF043	\$91.00	EVM089	\$61.00
5 m	EVC014	\$65.00	EVT044	\$86.00	EVF044	\$99.00	EVM090	\$76.00
10 m	EVC108	\$83.00	EVT045	\$98.00	EVF045	\$113.00	EVM109	\$116.00
15 m	EVC117	\$102.00	EVT109	\$104.00	-	-	EVM110	\$153.00
20 m	EVC118	\$119.00	EVT496	\$110.00	EVF663	\$140.00	-	-
25 m	-	-	EVT359	\$125.00	-	-	-	-

Jumper, Angled M12 Socket, Straight M12 Plug, 4pin, IP69K, 4 Amp (max)

Wiring	EVC		EVT		EVF	
	EVC Industrial	Price	EVT F&B	Price	EVF F&B	Price
	Black, TPU		Orange, PVC		Grey, MPPE	
	Ni Pl brass		SS 316 L		SS 316 L	
0.3 m	EVC015	\$46.00	EVT046	\$71.00	EVF046	\$83.00
0.6 m	EVC016	\$48.00	EVT047	\$73.00	EVF047	\$84.00
1 m	EVC017	\$48.00	EVT048	\$78.00	EVF048	\$90.00
2 m	EVC018	\$52.00	EVT049	\$79.00	EVF049	\$91.00
3 m	EVC103	\$54.00	EVT445	\$81.00	EVF445	\$92.00
5 m	EVC019	\$64.00	EVT050	\$86.00	EVF050	\$99.00
10 m	EVC109	\$83.00	EVT051	\$98.00	EVF051	\$115.00
15 m	EVC133	\$101.00	EVT098	\$104.00	-	-
20 m	EVC134	\$119.00	EVT099	\$114.00	-	-

Jumper, Straight M12 Socket, Angled M12 Plug, 4pin, IP69K, 4 Amp (max)

Wiring	EVC	
	Cable Material	Price
	Black, TPU	
	Ni Pl brass	
0.3 m	EVC025	\$46.00
0.6 m	EVC026	\$48.00
1 m	EVC027	\$49.00
2 m	EVC028	\$52.00
3 m	EVC140	\$57.00
5 m	EVC029	\$65.00
10 m	EVC342	\$73.00
20 m	EVC175	\$119.00

Other jumpers available on request:





Jumper · M12 / M12 · 4-pole (1 mm² for reduced voltage drop)

Wiring	EVF		EVF		EVF		EVF	
	EVF F&B	Price	EVF F&B	Price	EVF F&B	Price	EVF F&B	Price
Cable Material	Grey, MPPE		Grey, MPPE		Grey, MPPE		Grey, MPPE	
Nut Material	SS 316 L		SS 316 L		SS 316 L		SS 316 L	
0.25 m	EVF490	\$94.00	EVF497	\$94.00	-	-	-	-
0.5 m	EVF491	\$95.00	EVF498	\$95.00	-	-	-	-
1 m	EVF492	\$102.00	EVF499	\$102.00	-	-	-	-
2 m	EVF493	\$105.00	EVF500	\$105.00	EVF480	\$53.00	EVF485	\$53.00
5 m	EVF494	\$114.00	EVF501	\$114.00	EVF481	\$61.00	EVF486	\$61.00
10 m	EVF495	\$129.00	EVF502	\$129.00	EVF482	\$75.00	EVF487	\$75.00
20 m	EVF496	\$151.00	EVF503	\$151.00	EVF483	\$99.00	EVF488	\$99.00
50 m	-	-	-	-	EVF484	\$200.00	EVF489	\$200.00

Jumper · M12 / M12 · 4-pole (1 mm² for reduced voltage drop)

Wiring	EVC		EVC		EVC	
	EVC Industrial	Price	EVC Industrial	Price	EVC Industrial	Price
Cable Material	Black, TPU		Black, TPU		Black, TPU	
Nut Material	Ni PI brass		Ni PI brass		Ni PI brass	
0.25 m	EVC716	\$48.00	EVC723	\$48.00	-	-
0.5 m	EVC717	\$49.00	EVC724	\$49.00	-	-
1 m	EVC718	\$51.00	EVC725	\$51.00	-	-
2 m	EVC719	\$56.00	EVC726	\$56.00	EVC706	\$39.00
5 m	EVC720	\$69.00	EVC727	\$69.00	EVC707	\$45.00
10 m	EVC721	\$84.00	EVC728	\$84.00	EVC708	\$57.00
15 m	-	-	-	-	-	-
20 m	EVC722	\$107.00	EVC729	\$107.00	EVC709	\$92.00
50 m	-	-	-	-	EVC710	\$149.00





Jumper, Straight M12 Socket, Straight M12 Plug, 5pin, IP69K, 4 Amp (max)



Wiring	EVC	EVT		
	EVC Industrial	Price	EVT F&B	Price
Cable Material	Black, TPU		Orange, PVC	
Nut Material	Ni PI brass		SS 316 L	
0.6 m	EVC056	\$68.00	EVT059	\$76.00
1 m	EVC057	\$69.00	EVT060	\$77.00
2 m	EVC058	\$73.00	EVT061	\$78.00
5 m	EVC059	\$84.00	EVT062	\$79.00
10 m	EVC189	\$104.00	EVT063	\$95.00
15 m	EVC190	\$121.00	-	-
20 m	EVC201	\$141.00	-	-
25 m	EVC202	\$179.00	-	-

M12 Socket, 8pin, IP68/IP69K, 2 Amp (max)

Wiring	IP 68	IP 69K	IP 68	IP 69K	IP 68					
Cable Material	Black, TPU	Price	Orange PVC	Price	Black, TPU	Price	Orange PVC	Price	Black, PUR	Price
Nut Material	Ni PI brass		SS316L		Ni PI brass		SS316L		Ni PI brass	
2 m	E11231	\$82.00	-	-	E11950	\$65.00	-	-	E12281	\$92.00
5 m	E11232	\$102.00	E12295	\$86.00	E11807	\$99.00	-	-	E11230	\$118.00
10 m	E12169	\$104.00	E12296	\$129.00	E11311	\$131.00	E12433	\$136.00	E12360	\$164.00
25m	-	-	E12343	\$198.00	-	-	E12344	\$198.00	-	-
40 m	-	-	-	-	-	-	E12401	\$308.00	-	-
70 m	-	-	-	-	-	-	E12409	\$464.00	-	-

Wirable - Industrial M18 Sockets, 4pin, IP68, 4 Amp (max)

Wiring	E11	E11		
Material	Black, PA	Price	Black, PA	Price
-	E10137	\$28.00	E10013	\$28.00

M12 socket PNP/NPN Inverter module

Wiring	EVC Industrial	Price
Cable Material	Black, PUR	
Nut Material	Ni PI brass	
2 m	EVC01E	\$48.00
5 m	EVC05E	\$84.00

AC Power 1/2 " Socket, 3pin, IP67

Wiring	E11 Industrial	Price
Cable Material	Black, PUR	
Nut Material	Ni PI brass	
2 m	E12282	\$35.00
5 m	E10210	\$50.00



M12 Screened cables

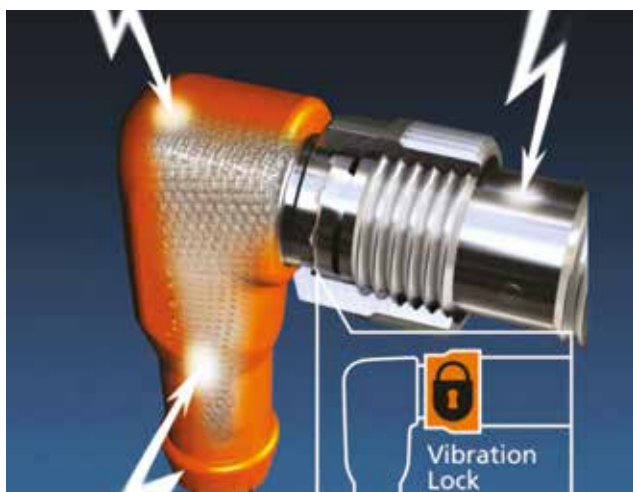

Screened (to the nut) M12 Socket, 8pin, IP69K, 2 Amp (max)

Wiring		EVC	
		EVC Industrial	Price
Cable Material		Black, TPU	
Nut Material		Ni Pl brass	
2 m		E12402	\$89.00
5 m		E12403	\$108.00
10 m		E12404	\$139.00

Screened M12 Socket, 4pin, IP69K, 4 Amp (max)

Wiring		(Screened to the nut) EVC		(Not screened to the nut) EVT		(Screened to the nut) EVC		(Screened to the nut) EVT	
		EVC Industrial	Price	EVT F&B	Price	EVC Industrial	Price	EVT F&B	Price
Cable Material		Black, TPU		Orange, PVC		Black, TPU		Orange, PVC	
Nut Material		Ni Pl brass		SS 316 L		Ni Pl brass		SS 316 L	
2 m		-	-	EVT385	\$40.00	EVC538	\$44.00	EVT381	\$40.00
5 m		EVC542	\$52.00	EVT386	\$48.00	EVC539	\$52.00	EVT382	\$48.00
10 m		EVC543	\$67.00	EVT387	\$62.00	EVC540	\$67.00	EVT383	\$62.00
15m		EVC698	\$80.00	-	-	-	-	EVT416	\$79.00
20 m		EVC857	\$116.00	EVT441	\$93.00	-	-	-	-
25 m		EVC767	\$123.00	EVT388	\$104.00	-	-	EVT384	\$104.00
35 m		-	-	EVT442	\$136.00	-	-	-	-
50 m		-	-	EVT443	\$179.00	-	-	-	-
70 m		-	-	-	-	-	-	EVT438	\$237.00

Screened M12 Socket, 5pin, IP69K, 4 Amp (max)

Wiring		(Screened to the nut) EVC		(Screened to the nut) EVT		(Screened to the nut) EVC		(Screened to the nut) EVT	
		EVC Industrial	Price			EVC Industrial	Price	EVT F&B	Price
Cable Material		Black, TPU				Black, TPU		Orange, PVC	
Nut Material		Ni Pl brass				Ni Pl brass		SS 316 L	
2 m		EVC547	\$46.00	EVT393	\$47.00	EVC544	\$47.00	EVT405	\$52.00
5 m		EVC548	\$58.00	EVT394	\$54.00	EVC545	\$58.00	EVT406	\$58.00
10 m		EVC549	\$78.00	EVT395	\$74.00	EVC546	\$78.00	EVT407	\$78.00
15m		EVC563	\$100.00	-	-	EVCA67	\$100.00	EVT569	\$94.00
25m		-	-	EVT396	\$135.00	-	-	EVT408	\$137.00



M12 LED cables



Problem
Traditional cordsets with transparent housings are hard to see.



ifm Solution
ifm cordsets have high visibility LEDs with good contrast.



LED - M12 Jumper cable with valve plug (Type A, B, C)

	M12 A type DIN	Price	M12 A type	Price	M12 B type	Price	M12 C type	Price
Cable Material	Black, PUR		Black, TPU		Orange, PVC		Grey, MPPE	
0.3 m	EVCB06	\$44.00	E11416	\$51.00	E11421	\$51.00	E11426	\$57.00
0.6 m	EVCB07	\$46.00	E11417	\$52.00	E11422	\$52.00	E11427	\$59.00
1 m	EVCB08	\$48.00	E11418	\$54.00	E11423	\$55.00	E11428	\$60.00
2 m	EVCB10	\$53.00	E11419	\$57.00	E11424	\$57.00	E11429	\$64.00
5 m	EVCB12	\$73.00	E11420	\$71.00	E11425	\$71.00	E11430	\$76.00

LED - M12 Socket, 4pin, IP69K, 4 Amp (max)

	EVC Industrial	Price	EVT F&B	Price	EVC Industrial	Price	EVM Outdoor	Price
Cable Material	Black, TPU		Orange, PVC		Black, TPU		Black, TPU	
Nut Material	Ni Pl brass		SS 316 L		Ni Pl brass		SS 316 L	
2 m	EVC007	\$42.00	EVT069	\$48.00	EVC644	\$39.00	EVM007	\$53.00
5 m	EVC008	\$48.00	EVT007	\$54.00	EVC645	\$45.00	EVM008	\$59.00
10 m	EVC009	\$58.00	EVT008	\$64.00	EVC646	\$54.00	EVM009	\$70.00
20 m	EVC130	\$78.00	EVT097	\$81.00	-	-	-	-
25 m	EVC091	\$97.00	EVT009	\$98.00	-	-	EVM011	\$105.00

(Note: Up to 70m)

M12 - Ex rated Sockets for hazardous areas

	EVC Industrial	Price	EVT F&B	Price
Cable Material	Blue, PUR		Blue, PUR	
Nut Material	Ni Pl brass		Ni Pl brass	
2 m	ENC01A	\$37.00	ENC04A	\$37.00
5 m	ENC02A	\$50.00	ENC05A	\$50.00
10 m	ENC03A	\$77.00	ENC06A	\$77.00

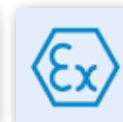



Jumper 1 x M12 Plug, 2 x M12 socket

Wiring	EVC		EVC		EVF		EVF	
	EVC Industrial	Price	EVC Industrial	Price	EVF F&B	Price	EVF F&B	Price
Cable Material	Black, TPU		Black, TPU		Grey, MPPE		Grey, MPPE	
Nut Material	Ni PI brass		Ni PI brass		SS 316 L		SS 316 L	
1 m	EVC431	\$70.00	EVC434	\$70.00	EVF329	\$105.00	EVF332	\$105.00
2 m	EVC432	\$73.00	EVC435	\$73.00	EVF330	\$108.00	-	-
5 m	EVC433	\$82.00	EVC436	\$82.00	EVF331	\$119.00	-	-

Note: For 8-pole sockets the core colours are not standardised. Refer to the ifm product datasheet.

Jumper, Angled M12 Socket, Straight M8 Plug, 3pin

Wiring	EVT	
	EVT F&B	Price
Cable Material	Orange, PVC	
Nut Material	SS 316 L	
0.6 m	EVT266	\$72.00
1 m	EVT267	\$73.00
2 m	EVT268	\$72.00
5 m	EVT269	\$78.00

Jumper, Straight M8 Socket, Straight M12 Plug, 3pin

Wiring	EVT	
	EVT F&B	Price
Cable Material	Orange, PVC	
Nut Material	SS 316 L	
0.3 m	EVT236	\$69.00
0.6 m	EVT237	\$69.00
1 m	EVT238	\$69.00
2 m	EVT239	\$72.00
5 m	EVT240	\$78.00

LED - M8 Socket, 3pin, IP69K, 3 Amp (max)

Wiring	EVC		EVT		EVF	
	EVC Industrial	Price	EVT F&B	Price	EVF F&B	Price
Cable Material	Black, TPU		Orange, PVC		Grey, MPPE	
Nut Material	Ni PI brass		SS 316 L		SS 316 L	
5 m	EVC148	\$48.00	EVT131	\$64.00	EVF127	\$51.00
10 m	-	-	EVT132	\$76.00	EVF128	\$61.00
25 m	-	-	EVT133	\$106.00	EVF129	\$92.00



Wirable - Industrial M8 Sockets & M8 Plugs, 3pin, IP68, 4 Amp (max)



Socket	Plug	E11		E11	
		EVC Industrial	Price	EVC Industrial	Price
Cable Material		Black, PA		Black, PA	
Nut Material		Ni Pl brass		Ni Pl brass	
-		E11552	\$30.00	E11550	\$30.00

Note: Cable sheath 3.0...5.0 mm range

Wirable - Industrial M8 Sockets & M8 Plugs, 4pin, IP68, 4 Amp (max)

Socket	Plug	E11		E11	
		EVC Industrial	Price	EVC Industrial	Price
Cable Material		Black, PA		Black, PA	
Nut Material		Ni Pl brass		Ni Pl brass	
-		E11553	\$29.00	E11551	\$29.00

Straight M8 Socket, 3pin, IP69K, 3 Amp (max)

Wiring	EVC	EVT	EVF	EVM				
	EVC Industrial	Price	EVT F&B	Price	EVF F&B	Price	EVM Outdoor	Price
Cable Material	Black, TPU		Orange, PVC		Grey, MPPE		Black, TPU	
Nut Material	Ni Pl brass		SS 316 L		SS 316 L		SS 316 L	
2 m	EVC141	\$35.00	EVT122	\$40.00	EVF122	\$39.00	EVM020	\$46.00
5 m	EVC142	\$41.00	EVT123	\$52.00	EVF123	\$51.00	EVM021	\$53.00
10 m	EVC143	\$50.00	EVT124	\$62.00	EVF124	\$61.00	EVM022	\$63.00
15 m	-	-	EVT272	\$72.00	-	-	EVM023	\$80.00
20 m	EVC501	\$71.00	-	-	-	-	-	-
25 m	-	-	EVT125	\$94.00	EVF125	\$92.00	-	-
45 m	EVC502	\$119.00	-	-	-	-	-	-
50 m	-	-	EVT214	\$139.00	-	-	-	-

Angled M8 Socket, 3pin, IP69K, 3 Amp (max)

Wiring	EVC	EVT	EVF			
	EVC Industrial	Price	EVT F&B	Price	EVF F&B	Price
Cable Material	Black, TPU		Orange, PVC		Grey, MPPE	
Nut Material	Ni Pl brass		SS 316 L		SS 316 L	
2 m	EVC144	\$35.00	EVT126	\$40.00	EVF126	\$39.00
5 m	EVC145	\$41.00	EVT127	\$52.00	EVF127	\$51.00
10 m	EVC146	\$50.00	EVT128	\$62.00	EVF128	\$61.00
25 m	-	-	EVT129	\$94.00	EVF129	\$92.00
30 m	-	-	EVT413	\$106.00	-	-



Straight M8 Socket, 4pin, IP69K, 3 Amp (max)

Wiring	EVC		EVT		EVF		EVM	
	EVC Industrial	Price	EVT F&B	Price	EVF F&B	Price	EVM Outdoor	Price
	Black, TPU		Orange, PVC		Grey, MPPE		Black, TPU	
	Ni PI brass		SS 316 L		SS 316 L		SS 316 L	
2 m	EVC150	\$37.00	EVT134	\$41.00	EVF134	\$41.00	EVM028	\$48.00
5 m	EVC151	\$43.00	EVT135	\$49.00	EVF135	\$48.00	EVM029	\$54.00
10 m	EVC152	\$53.00	EVT136	\$59.00	EVF136	\$58.00	EVM030	\$65.00
15 m	EVC387	\$63.00	EVT274	\$78.00	EVF274	\$67.00	EVM031	\$83.00
20 m	-	-	-	-	EVF646	\$76.00	-	-
25 m	-	-	EVT137	\$91.00	EVF137	\$89.00	-	-
40 m	EVC424	\$116.00	-	-	-	-	-	-
50 m	EVCA50	\$130.00	-	-	-	-	-	-

Angled M8 Socket, 4pin, IP69K, 3 Amp (max)

Wiring	EVC		EVT		EVF	
	EVC Industrial	Price	EVT F&B	Price	EVF F&B	Price
	Black, TPU		Orange, PVC		Grey, MPPE	
	Ni PI brass		SS 316 L		SS 316 L	
2 m	EVC153	\$37.00	EVT138	\$41.00	EVF138	\$41.00
5 m	EVC154	\$43.00	EVT139	\$49.00	EVF139	\$48.00
10 m	EVC155	\$53.00	EVT140	\$59.00	EVF140	\$58.00
15 m	-	-	EVT275	\$78.00	-	-
25 m	-	-	EVT141	\$91.00	EVF141	\$89.00

Jumper, Straight M8 Socket, Straight M8 Plug, 3pin, IP69K, 3 Amp (max)

Wiring	EVC		EVT	
	EVC Industrial	Price	EVT F&B	Price
	Black, TPU		Orange, PVC	
	Ni PI brass		SS 316 L	
0.3 m	EVC265	\$45.00	EVT142	\$70.00
0.6 m	EVC266	\$47.00	-	-
1 m	EVC267	\$49.00	EVT144	\$78.00
2 m	EVC268	\$52.00	EVT145	\$79.00
5 m	EVC269	\$65.00	EVT146	\$86.00
10 m	EVC467	\$78.00	EVT147	\$97.00
15 m	EVC518	\$94.00	-	-



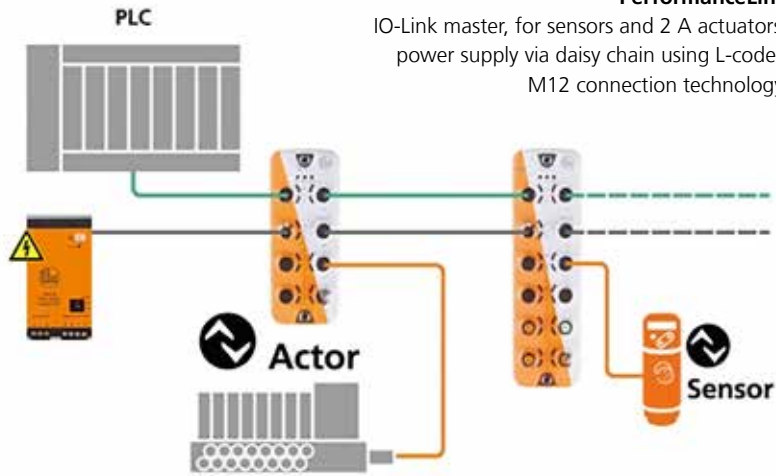

PerformanceLine

IO-Link master, for sensors and 2 A actuators, power supply via daisy chain using L-coded M12 connection technology.

M12 L-CODED EVC series - Industrial

Wiring	EVCA	Price	EVCA	Price	EVCA	Price	EVCA	Price	
	EVCA Industrial		EVCA Industrial		Cable	EVCA Industrial		EVCA Industrial	
	Grey, TPU		Grey, TPU		Nut	Ni PI brass		Ni PI brass	
	Ni PI brass		Ni PI brass						
2 m	EVCA15	\$101.00	EVCA20	\$101.00	0.25 m	EVCA25	\$138.00	EVCA32	\$135.00
5 m	EVCA16	\$145.00	EVCA21	\$145.00	0.5 m	EVCA26	\$142.00	EVCA33	\$142.00
10 m	EVCA17	\$216.00	EVCA22	\$216.00	1 m	EVCA27	\$152.00	EVCA34	\$152.00
20 m	EVCA18	\$365.00	EVCA23	\$365.00	2 m	EVCA28	\$167.00	EVCA35	\$167.00
50 m	EVCA19	\$771.00	EVCA24	\$771.00	5 m	EVCA29	\$207.00	EVCA36	\$207.00
-	-	-	-	-	10 m	EVCA30	\$255.00	EVCA37	\$255.00
-	-	-	-	-	20 m	EVCA31	\$378.00	EVCA38	\$378.00

M12 L-coded EVF series - F&B

Wiring	EVF	Price	EVF	Price	EVF	Price	EVF	Price	EVF	Price
	EVF		EVF		EVF		EVF		EVF	
Cable Length (m)										
0.25 m	-	-	-	-	EVF621	\$164.00	EVF628	\$164.00	EVF637	\$164.00
0.5 m	-	-	-	-	EVF622	\$169.00	EVF629	\$169.00	EVF638	\$169.00
1 m	-	-	-	-	EVF623	\$179.00	EVF630	\$179.00	EVF639	\$179.00
2 m	EVF611	\$118.00	EVF616	\$118.00	EVF624	\$194.00	EVF631	\$194.00	EVF640	\$194.00
5 m	EVF612	\$162.00	EVF617	\$162.00	EVF625	\$232.00	EVF632	\$232.00	EVF641	\$232.00
10 m	EVF613	\$232.00	EVF618	\$232.00	EVF626	\$280.00	EVF633	\$280.00	EVF642	\$280.00
20 m	EVF614	\$380.00	EVF619	\$380.00	EVF627	\$402.00	EVF634	\$402.00	EVF643	\$402.00
50 m	EVF615	\$779.00	EVF620	\$779.00	-	-	-	-	-	-





Type	Description	Order no	Price
M12 cable plug · 4 poles · straight			
	2.0 m	EVC893	\$34.00
	5.0 m	EVC894	\$67.00
	10.0 m	EVC895	\$121.00
	20.0 m	EVC896	\$229.00
	50.0 m	EVC897	\$555.00
M12 cable plug · 4 poles · angled			
	2.0 m	EVC898	\$34.00
	5.0 m	EVC899	\$67.00
	10.0 m	EVC900	\$121.00
	20.0 m	EVC901	\$229.00
	50.0 m	EVC902	\$555.00
M12 connection cable · 4 poles · straight-straight			
	0.25 m	EVC903	\$38.00
	0.5 m	EVC904	\$40.00
	1.0 m	EVC905	\$46.00
	2.0 m	EVC906	\$57.00
	5.0 m	EVC907	\$89.00
	10.0 m	EVC908	\$144.00
	20.0 m	EVC909	\$252.00
M12 cable plug · 4 poles · straight-angled			
	0.25 m	EVC910	\$38.00
	0.5 m	EVC911	\$40.00
	1.0 m	EVC912	\$46.00
	2.0 m	EVC913	\$57.00
	5.0 m	EVC914	\$89.00
	10.0 m	EVC915	\$144.00
	20.0 m	EVC916	\$252.00
M12 connection cable · 4 poles · angled-angled			
	0.25 m	EVC917	\$38.00
	0.5 m	EVC918	\$40.00
	1.0 m	EVC919	\$46.00
	2.0 m	EVC920	\$57.00
	5.0 m	EVC921	\$89.00
	10.0 m	EVC922	\$144.00
	20.0 m	EVC923	\$252.00

Type	Description	Order no	Price
Connection cable M12 connector			
	2.0 m	EVC943	\$81.00
	5.0 m	EVC944	\$164.00
	2.0 m	EVC945	\$81.00
	5.0 m	EVC946	\$164.00
Connection cable M12 socket			
	2.0 m	EVC939	\$84.00
	5.0 m	EVC940	\$168.00
	2.0 m	EVC941	\$84.00
	5.0 m	EVC942	\$168.00
Connection cable with terminating resistor 120 Ω, M12 socket			
	2.0 m	EVC957	\$97.00
	5.0 m	EVC958	\$181.00
	2.0 m	EVC959	\$97.00
	5.0 m	EVC960	\$193.00
	10.0 m	EVC961	\$288.00
Connection cable M12 connector / M12 socket			
	1.0 m	EVC947	\$97.00
	2.0 m	EVC948	\$118.00
	5.0 m	EVC949	\$200.00
Connection cable M12 connector / M12 socket			
	1.0 m	EVC950	\$97.00
	2.0 m	EVC951	\$118.00
	5.0 m	EVC952	\$200.00
Connection cable M12 connector / M12 socket			
	1.0 m	EVC953	\$97.00
	2.0 m	EVC954	\$118.00
	5.0 m	EVC955	\$200.00
	10.0 m	EVC956	\$292.00
Connection cable with terminating resistor 120 Ω, M12 connector / M12 socket			
	2.0 m	EVC962	\$131.00
	5.0 m	EVC963	\$213.00
	10.0 m	EVC964	\$305.00
Connection cable with terminating resistor 120 Ω, M12 connector / M12 socket			
	2.0 m	EVC965	\$131.00
	5.0 m	EVC966	\$213.00
	10.0 m	EVC967	\$305.00

Wiring diagram

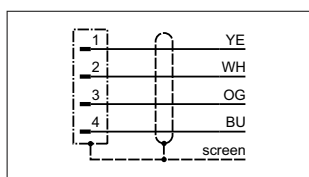

Example EVC898

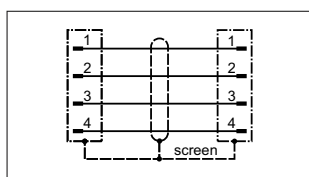

Example EVC917

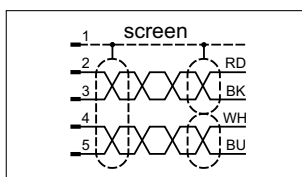

Example EVC943

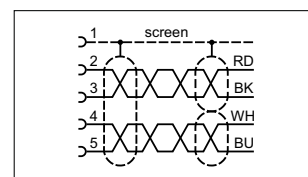

Example EVC939



Wiring Diagrams

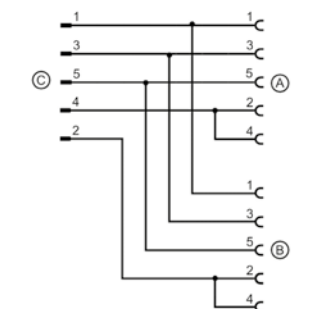
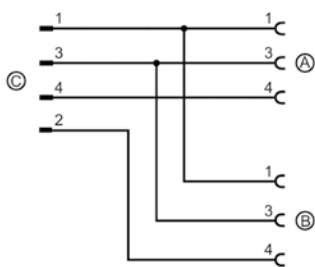
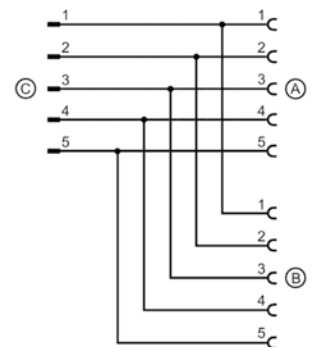
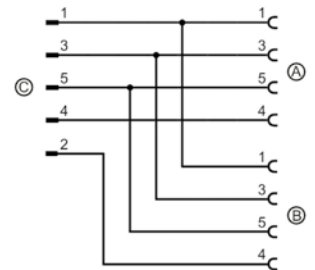
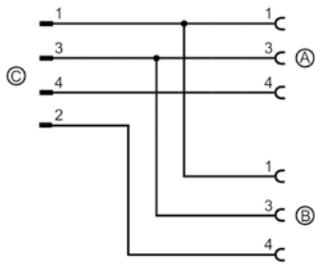

Type	Description	Order no.	Price
Connector: 2 x M12 Sockets, 1x M12 Plug			
	Housing: PA orange; Sealing: FKM, brass, nickel-plated	EBC113	\$45.00
	Housing: PA orange; Halogen-free; Sealing: EPDM, stainless steel (1.4404 / 316L)	EBT006	\$50.00
	Housing: PA grey; Halogen-free; Sealing: EPDM, stainless steel (1.4404 / 316L)	EBF006	\$52.00
Connector: 2 x M12 Sockets, 1x M12 Plug			
	Housing: PA orange; Sealing: FKM, brass, nickel-plated	EBC115	\$45.00
	Housing: PA grey; Halogen-free; Sealing: EPDM, stainless steel (1.4404 / 316L)	EBF008	\$52.00
Connector: 2 x M12 Sockets, 1x M12 Plug			
	Housing: PA orange; Sealing: FKM, brass, nickel-plated	EBC116	\$45.00
	Housing: PA orange; Halogen-free; Sealing: EPDM, stainless steel (1.4404 / 316L)	EBT009	\$50.00
	Housing: PA grey; Halogen-free; Sealing: EPDM, stainless steel (1.4404 / 316L)	EBF009	\$52.00
Connector: 2 x M8 Sockets, 1x M12 Plug			
	Housing: PA orange; Sealing: FKM, brass, nickel-plated	EBC112	\$43.00
	Housing: PA grey; Halogen-free; Sealing: EPDM, stainless steel (1.4404 / 316L)	EBF012	\$52.00
	Housing: PA orange; Halogen-free; Sealing: EPDM, stainless steel (1.4404 / 316L)	EBT012	\$48.00
Connector: 2 x M12 Sockets, 1x M12 Plug			
	Housing: PA orange; Sealing: FKM, brass, nickel-plated	EBC114	\$45.00

M12 Passive Splitter Box, IP68



Type	Ports	Signals on contact	LED	Output	Connection	Article no.	Price
	4	2 and 4	•	PNP	5 m	EBC016	\$273.00
	4	2 and 4	•	PNP	10 m	EBC028	\$343.00
	6	2 and 4	•	PNP	5 m	EBC020	\$343.00
	6	2 and 4	•	PNP	10 m	EBC032	\$467.00
	8	2 and 4	8	PNP	M12	EBC138	\$190.00
	8	2 and 4	–	–	5 m	EBC022	\$354.00
	8	2 and 4	–	–	10 m	EBC034	\$443.00
	8	2 and 4	•	PNP	5 m	EBC024	\$386.00
	8	2 and 4	•	PNP	10 m	EBC035	\$360.00

M12 Passive Splitter Box, IP69K



Type	Ports	Signals on contact	LED	Output	Connection	Article no.	Price
	8	2 and 4	-	PNP	5 m	EBF026	\$533.00
	8	2 and 4	-	PNP	10 m	EBF027	\$619.00
	8	2 and 4	-	PNP	15 m	EBF028	\$705.00
	8	2 and 4	-	PNP	20 m	EBF029	\$873.00

Panel Wall connectors



Type	Size	Pins	Length	Mounting Thread	Article no.	Price
M12 Plug, brass, nickel-plated						
	M12	4 Wire	120 mm	M20	E11295	\$30.00
	M12	4 Wire	500 mm	M20	E11293	\$30.00
	M12	5 Wire	500 mm	M16	E11588	\$30.00
	M12	8 Wire	500 mm	PG9	E11194	\$32.00
M12 Socket, brass, nickel-plated						
	M12	4 Wire	500 mm	PG9	E11067	\$35.00
	M12	5 Wire	500 mm	M16	E12408	\$26.00
	M12	8 Wire	500 mm	PG9	E11601	\$53.00

Wall passage connectors



Type	Size	Pins	Length	Mounting Thread	Article no.	Price
M12 - M12 Plug, 5-wire						
	M12	5 Wire		Brass, nickel-plated	E73008	\$45.00
	M12	5 Wire		Stainless steel	E73009	\$59.00

Magnetic Sensors



Learn more



Magnetic Sensors



- Long sensing range even through non-magnetisable metals
- Temperature-stable and reproducible switch point
- High protection rating ideal for the food and beverage industry
- Wide operating temperature range
- Food-grade full-metal housing

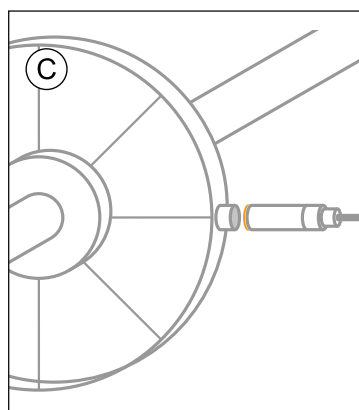
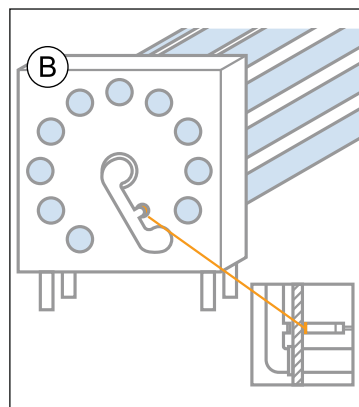
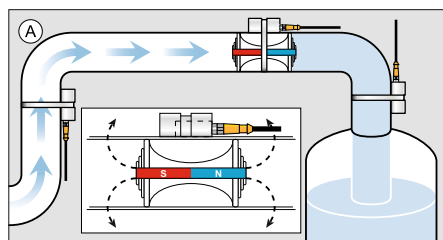

Type x Length	Sensing range [mm]	Output function	Electrical design	Article no.	Price
4-pole					
M8 x 60	60	NO	DC, PNP	ME5010	\$172.00
M8 x 60	60	NO	DC, PNP	ME5011	\$167.00
M12 x 60	60	NO	DC, NPN	MFS209	\$151.00
M12	60	NO	DC, PNP	MFS211	\$151.00
M12	60	NO	DC, PNP	MFT202	\$184.00
4-pole					
M18 x 60	70	NO	DC, PNP	MG5204	\$151.00
M18	70	NO	DC, PNP	MGT203	\$184.00

Accessories

Type	Description	Article no.	Price
	Damping element M3.0, barium ferrite. IATA-compliant pack of 5.	E12707	\$91.00
	Damping element M5.0, barium ferrite. IATA-compliant pack of 5.	E12709	\$149.00



Inductive position sensors

K1 sensors detect all metals at the same range
IO-Link sensors are configurable in every way!



[Learn more](#)

M5 Inductive sensors

Size (mm)	Material	Range (mm)	Operating Voltage (V)	Output Function	Temp Range (°C)	Max. Freq'y (Hz)	Max. Load (mA)	Electrical Connection	Note	Order No.	Price
Industrial Applications, IP67											
M5, L=30	SS-316L	0.8f	10-36 DC	PNP, NO	-25 70	2,000	100	2m Cable		IY5029	\$187.00
M5, L=45	SS-316L	0.8f	10-36 DC	PNP, NO	-25 70	2,000	100	M8 3w		IY5036	\$201.00

M8 Inductive sensors

Size (mm)	Material	Range (mm)	Operating Voltage (V)	Output Function	Temp Range (°C)	Max. Freq'y (Hz)	Max. Load (mA)	Electrical Connection	Note	Order No.	Price
Industrial Applications, IP67											
M8, L=40	Metal	3f	10-30 DC	PNP/NPN	0 60	800	100	M8		IE5338	\$134.00
M8, L=40	Metal	3f	10-30 DC	PNP, NO	-40 85	2,000	100	M8	K1	IES200	\$130.00
M8, L = 40	SS-316L	5nf	10...30 DC	PNP/NPN, NO	0 60	600	100	M8		IE5340	\$134.00
M8, L=50	SS-316L	2f	10-36 DC	PNP, NO	-25 70	100	100	M8	Coolant	IEC201	\$142.00
M8, L=50	Metal	2f	10-36 DC	PNP, NO	-25 70	1,300	300	M8		IE5287	\$175.00
M8, L = 50	SS-316L	2nf	10...30 DC	PNP, NO	-25 80	2,000	100	M12		IE5295	\$188.00
M8, L=50	Metal	2f	10-36 DC	PNP, NC	-25 70	1,300	200	M8		IE5319	\$202.00
M8, L=50	Metal	2f	10-36 DC	PNP, NO	0 100	1,000	100	M12		IE5379	\$164.00
M8, L=55	SS-316L	2nf	10-36 DC	PNP, NO	-25 80	2,000	200	M12		IE5295	\$188.00
M8, L=60	Metal	4nf	10-36 DC	PNP, NO	-25 70	1,000	100	M8		IE5391	\$146.00
M8, L=62	Metal	2f	10-36 DC	PNP, NO	-25 70	1,000	250	M12		IE5257	\$171.00
M8, l=62	Metal	4nf	10-36DC	PNP, NO	-25 70	300	200	M12		IE5288	\$171.00
F&B Applications, IP69k											
M8, L=40	SS-316L	3f	10-30 DC	PNP, NO	-40 85	2,000	100	M8	K1	IES200	\$130.00
M8, L=40	SS-316L	6nf	10-30 DC	PNP, NO	-40 85	2,000	100	M8	K1	IES201	\$130.00



Inductive sensors



M12 Inductive sensors

Size (mm)	Material	Range (mm)	Operating Voltage (V)	Output Function	Temp Range (°C)	Max. Freq'y (Hz)	Max. Load (mA)	Electrical Connection	Note	Order No.	Price
Industrial Applications, IP67											
M12, L=40	Metal	4f	10-30 DC	PNP, NO	-40 85	700	100	2m Cable		IFS256	\$121.00
M12, L=40	SS-316L	4f	10...30 DC	PNP, NO	-40 85	100	100	2m Cable		IFC278	\$124.00
M12, L=45	Metal	2f	10-30 DC	PNP, NO	-25 70	700	200	M12	Coolant	IFC239	\$138.00
M12, L=45	Metal	4f	10-30 DC	PNP, NO	-25 70	700	100	M12		IFS204	\$118.00
M12, L=45	Metal	2f	10-30 DC	PNP, NO	-25 80	1,500	100	M12		IF5538	\$149.00
M12, L=50	Metal	7nf	10-36 DC	PNP, NO	-25 70	700	100	M12		IFS205	\$118.00
M12, L=45	Metal	4f	10-30 DC	PNP, NC	-25 70	700	100	M12		IFS206	\$118.00
M12, L=45	Metal	4f	10-30 DC	PNP, NO	-40 85	700	100	M12		IFS244	\$118.00
M12, L=60	Metal	4f	10-36 DC	PNP, NO	-25 70	700	100	M12		IFC229	\$140.00
M12, L=60	Metal	4f	10...30 DC	PNP, NO	-25 70	700	200	M12		IF5915	\$159.00
M12, L=60	Metal	4f	10-60 DC	PNP, NO	-40 85	700	100	M12		IF5240	\$118.00
M12, L=60	Metal	4f	10-30 DC	NPN, NO	-40 85	700	100	M12		IFS242	\$118.00
M12, L=60	Metal	4f	10-30 DC	PNP, NC	-40 85	700	100	M12		IFS248	\$118.00
M12, L=60	Metal	4f	10-30 DC	PNP, NO	-40 85	2,000	100	M12	K1	IFS304	\$125.00
M12, L=60	Metal	10nf	10-30 DC	PNP, NO	-40 85	2,000	100	M12		IFS306	\$125.00
M12, L=65	Metal	8nf	10-30 DC	PNP, NO	-25 70	2,000	100	M12	Coolant	IFC246	\$125.00
M12, L=65	Metal	3f	10-30 DC	PNP, NO	-25 70	2,000	100	M12	Weld	IFW200	\$134.00
M12, L=73	Metal	4f	20-140 AC	NO	-25 80	25	200	M12		IF0311	\$239.00
M12, L=72	PBT	4f	20-250 AC	NO	-25 80	25	200	2m Cable		IF0003	\$212.00
M12, L=80	Metal	2f	10-30 DC	PNP, NO	-25 80	800	200	M12		IF5580	\$149.00

Size (mm)	Material	Range (mm)	Operating Voltage (V)	Output Function	Temp Range (°C)	Max. Freq'y (Hz)	Max. Load (mA)	Electrical Connection	Note	Order No.	Price
F&B Wash-down Applications, IP69K											
M12, L=45	SS-316L	4f	10-30 DC	PNP, NO	-40 85	2,000	100	M12	K1	IFS297	\$125.00
M12, L=45	SS-316L	10nf	10-30 DC	PNP, NO	-40 85	2,000	100	M12	K1	IFS299	\$125.00
M12, L=45	SS-316L	4f	10-30 DC	PNP, NO	0 100	800	100	M12	FDA	IFT203	\$138.00
M12, L=45	SS-316L	4f	10...30 DC	PNP, NC	0 100	800	100	M12		IFT204	\$138.00
M12, L=50	Metal	4nf	10...30 DC	PNP, NO	-25 70	700	100	M12		IFS215	\$128.00
M12, L=50	SS-316L	7nf	10-36 DC	PNP, NO	0 100	800	100	M12	FDA	IFT200	\$138.00
M12, L=60	SS-316L	3f	10-36 DC	PNP, NO	-40 60	100	100	M12	3D,3G	IF503A	\$175.00
M12, L=60	Metal	4nf	10...30 DC	PNP/NPN, NO/NC	-40 85	600	100	M12	IO-Link	IF6124	\$136.00
M12, L=60	SS-316L	4f	10-30 DC	PNP, NO	-40 85	2,000	100	M12	K1	IFS304	\$125.00
M12, L=60	SS-316L	8nf	10...30 DC	PNP, NO	-40 85	2,000	100	M12		IFS305	\$125.00
M12, L=60	all SS-316L	3f	10-30 DC	PNP, NO	0 100	100	100	M12	FDA	IFT240	\$156.00
M12, L=60	SS-316L	6nf	10...30 DC	PNP, NO	0 100	250	100	M12	FDA	IFT245	\$183.00
M12, L=60	SS-316L	6nf	10...30 DC	NPN, NO	0 100	250	100	M12	FDA	IFT246	\$183.00
M12, L=60	all SS-316L	3.6f	10-30 DC	PNP/NPN, NO/NC	0 100	100	100	M12	IO-Link	IFT258	\$157.00
M12, L=70	SS-304	7nf	10-36 DC	PNP/NPN	-40 85	300	100	M12	Mobile	IFM204	\$124.00
M12, L=70	SS-304	4f	10-60 DC	PNP, NO	-40 85	400	200	M12	Mobile	IFM205	\$141.00
M12, L=70	SS-304	7nf	10-60 DC	PNP, NO	-40 85	300	200	M12	Mobile	IFM206	\$141.00
M12, L=70	SS-316L	7nf	10-30 DC	PNP/NPN, NO	0 100	700	100	M12	FDA	IFT202	\$156.00
M12, L=70	SS-316L	4f	10-30 DC	PNP/NPN, NO	0 100	500	100	M12	FDA	IFT205	\$156.00
M12, L=70	SS-316L	4f	10-36 DC	PNP, NO	0 100	700	100	M12	FDA	IFT216	\$154.00

Inductive sensors

M18 Inductive sensors



Size (mm)	Material	Range (mm)	Operating Voltage (V)	Output Function	Temp Range (°C)	Max. Freq'y (Hz)	Max. Load (mA)	Electrical Connection	Note	Order No.	Price
Industrial Applications, IP67											
M18, L = 40	Metal	8f	10...30 DC	NPN NO	-40 85	400	100	2m Cable		IGS250	\$136.00
M18, L = 40	Metal	8f	10...30 DC	PNP, NO	-40 85	400	100	2m Cable		IGS248	\$136.00
M18, L=45	Metal	8f	10-30 DC	PNP, NO	-25 70	400	100	M12		IGS204	\$118.00
M18, L=45	Metal	8f	10-30 DC	PNP, NO	-40 85	400	100	M12		IGS236	\$132.00
M18, L=45	Metal	12nf	10-30 DC	PNP, NO	-40 85	300	100	M12		IGS237	\$132.00
M18, L=45	Metal	8f	10-30 DC	PNP, NC	-40 85	400	100	M12		IGS252	\$132.00
M18, L=45	Metal	8f	10-30 DC	PNP, NC	-25 70	400	100	M12		IGS206	\$118.00
M18, L=50	Metal	12nf	10-30 DC	PNP, NO	-25 70	300	100	M12		IGS205	\$118.00
M18, L=60	Metal	12nf	10-30 DC	PNP/NPN, NO	-40 85	300	100	M12	IO-Link	IG6616	\$153.00
M18, L=60	Metal	8f	10-30 DC	PNP, NO	-40 85	400	100	M12		IGS232	\$132.00
M18, L=60	Metal	12nf	10-30 DC	PNP, NO	-40 85	300	100	M12		IGS233	\$132.00
M18, L=60	Metal	8f	10-30 DC	NPN, NO	-40 85	400	100	M12		IGS234	\$132.00
M18, L=60	Metal	12nf	10-30 DC	NPN, NO	-40 85	300	100	M12		IGS235	\$132.00
M18, L=60	Metal	8f	10-30 DC	PNP, NC	-40 85	400	100	M12		IGS240	\$132.00
M18, L=60	Metal	7.5f	10-30 DC	PNP/NPN, NO	-40 85	100	100	M12	IO-Link	IGC260	\$170.00
M18, L=60	Metal	15nf	10...30 DC	PNP, NO	-40 85	2,000	100	M12		IGS278	\$134.00
M18, L=65	Metal	5f	10-30 DC	PNP, NO	-25 70	2,000	100	M12	Coolant	IGC232	\$162.00
M18, L=65	Metal	12nf	10-30 DC	PNP, NO	-25 70	2,000	100	M12	Coolant	IGC233	\$162.00
M18, L=70	Metal	8f	10-36 DC	PNP/NPN, NO/NC	-25 70	400	100	M12		IG5953	\$155.00
M18, L=70	Metal	8f	10-30 DC	PNP/NPN, NO	-25 70	400	100	M12		IGS208	\$133.00
M18, L=70	Metal	12nf	10-30 DC	PNP, NO	-25 70	300	100	M12		IGS213	\$123.00
M18, L=70	Metal	8f	10-30 DC	PNP, NO	-25 70	400	100	M12		IGS212	\$123.00
M18, L=70	Metal	12nf	10-30 DC	PNP, NO	-25 80	300	200	M12		IG5841	\$185.00
M18, L=72	Metal	12nf	10-36 DC	PNP/NPN, NO/NC	-25 70	250	100	M12		IG5954	\$155.00
M18, L=77	Metal	8nf	10-36 DC	PNP, NO	0 180	400	150	5m Cable	High temp	IG6119	\$562.00
M18, L=80	PBT	5f	20-250AC/DC	NO	-25 80	50	100	2m Cable		IG0005	\$221.00
M18, L=80	Metal	5f	20-250AC/DC	NO	-25 80	50	100	2m Cable		IG0011	\$229.00
M18, L=80	PBT	5f	20-250AC/DC	NC	-25 80	50	100	10m Cable		IG0097	\$239.00
M18, L=80	PBT	8f	10-55 DC	PNP/NPN, NO	-25 80	300	400	2m Cable		IG5533	\$132.00
M18, L=80	Metal	8nf	10-30 DC	PNP, Complmtry	-25 80	300	200	M12		IG5842	\$147.00



Accessories

Type	Description	Order no.	Price
	Angle bracket for type M18, stainless steel	E10736	\$8.00

Inductive sensors



M18 Inductive sensors

Size (mm)	Material	Range (mm)	Operating Voltage (V)	Output Function	Temp Range (°C)	Max. Freq'y (Hz)	Max. Load (mA)	Electrical Connection	Note	Order No.	Price
F&B Wash-down Applications, IP69K											
M18, L=45	SS-316L	8f	10-30 DC	PNP, NO	-40 85	2,000	100	M12	K1	IGS287	\$141.00
M18, L=45	all SS-316L	8f	10-30 DC	PNP, NO	0 100	100	100	M12	FDA	IGT258	\$173.00
M18, L=45	all SS-316L	10qf	10-30 DC	PNP, NO	0 100	200	100	M12	FDA	IGT203	\$153.00
M18, L=50	SS-316L	12nf	10-36 DC	PNP, NO	0 100	300	100	M12	FDA	IGT201	\$153.00
M18, L=50	SS-316L	12nf	10-36 DC	PNP, NO	0 100	300	100	M12	FDA	IGT200	\$153.00
M18, L=57	SS-316L	8f	10-36 DC	PNP, NO	0 100	600	100	6m Cable	FDA	IGT206	\$175.00
M18, L=60	all SS-316L	8f	10-30 DC	PNP, NC	-40 85	2,000	100	M12	K1	IGS306	\$125.00
M18, L=60	SS-316L	8f	10-30 DC	PNP, NO	-40 85	2,000	100	M12	K1	IGS290	\$141.00
M18, L=60	SS-316L	15nf	10-30 DC	PNP, NO	-40 85	2,000	100	M12	K1	IGS292	\$141.00
M18, L=60	SS-316L	8f	10-30 DC	PNP, Complmtry	-40 85	2,000	100	M12	K1	IGS300	\$153.00
M18, L=60	all SS-316L	7.5f	10-30 DC	PNP/NPN, NO/NC	0 100	100	100	M12	IO-Link	IGT260	\$170.00
M18, L=70	SS-316L	5f	10-36 DC	PNP, NO	-40 60	100	100	M12	3D,3G	IG510A	\$175.00
M18, L=70	SS-316L	12nf	10-30 DC	PNP, NO	-40 60	500	100	M12	3D,3G	IG511A	\$204.00
M18, L=70	SS-304	8f	10-36 DC	PNP/NPN, NO	-40 85	200	100	M12	Mobile	IGM200	\$124.00
M18, L=70	SS-304	12nf	10-36 DC	PNP/NPN, NO	-40 85	200	100	M12	Mobile	IGM201	\$124.00
M18, L=70	SS-304	8f	10-60 DC	PNP, NO	-40 85	200	200	M12	Mobile	IGM204	\$141.00
M18, L=70	SS-304	12nf	10-60 DC	PNP, NO	-40 85	200	200	M12	Mobile	IGM205	\$141.00
M18, L=70	SS-316L	5f	20-140AC/DC	NO	0 100	25	80	1/2"		IGT002	\$196.00
M18, L=70	SS-316L	12nf	10-30 DC	PNP/NPN, NO	0 100	300	100	M12	FDA	IGT202	\$173.00
M18, L=70	SS-316L	8f	10-36 DC	PNP/NPN, NO	0 100	400	100	M12	FDA	IGT205	\$173.00
M18, L=70	SS-316L	5f	10-36 DC	PNP, NO	0 100	100	100	M12	FDA	IGT247	\$173.00
M18, L=70	all SS-316L	12nf	10-36 DC	PNP, NO	0 100	500	100	M12	FDA	IGT249	\$202.00
M18, L=81	SS-316L	12nf	10-30 DC	PNP/NPN, NO	0 100	300	100	10m Cable	FDA	IGT213	\$192.00

F&B Washdown sensor approvals

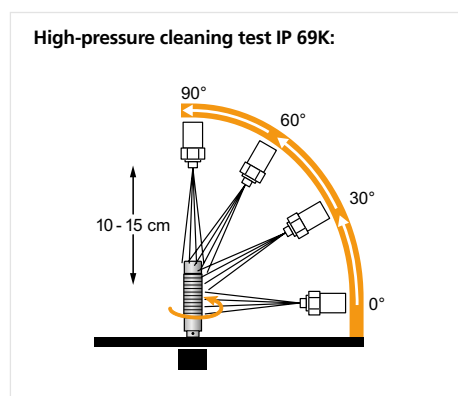

Fine jets of water is sprayed with 100 bar from a distance of 10 to 15 cm. The hot water at 80 °C is sprayed in cycles of 30 seconds.

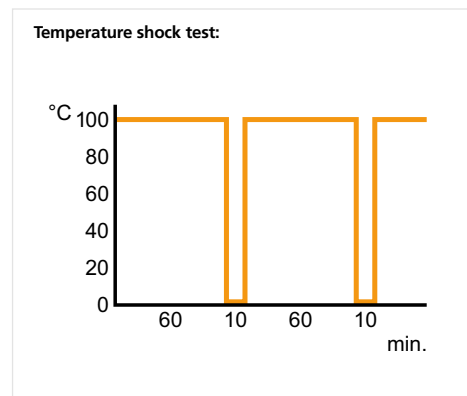

The products are subjected to temperature fluctuations from 0 to 100 °C in short intervals.

- High-grade stainless steel
- Operating temperature up to 100°C
- IP 67, IP 68, IP 69-K
- Resistant to aggressive media

Inductive sensors

M30 Inductive sensors



Size (mm)	Material	Range (mm)	Operating Voltage (V)	Output Function	Temp Range (°C)	Max. Freq'y (Hz)	Max. Load (mA)	Electrical Connection	Note	Order No.	Price
Industrial Applications, IP67											
M30, L=60	Metal	15f	10-30 DC	PNP, NO	-40 85	100	100	M12		IIS226	\$149.00
M30, L=60	Metal	22nf	10-30 DC	PNP, NO	-40 85	100	100	M12		IIS227	\$149.00
M30, L = 60	Metal	30nf	10...30 DC	PNP, NO	-40 85	2,000	100	M12		IIS268	\$150.00
M30, L = 60	Metal	10f	10...30 DC	PNP, NO	-25 70	50	100	M12		IIC224	\$170.00
M30, L=60	Metal	14nf	10-36 DC	PNP/NPN, NO	0 100	100	100	-	10m cable	IIS206	\$166.00
M30, L=60	SS-316L	15f	10-30 DC	PNP, NO	-40 85	2,000	100	M12	K1	IIS282	\$156.00
M30, L=60	SS-316L	30nf	10-30 DC	PNP, NO	-40 85	2,000	100	M12	K1	IIS284	\$156.00
M30, L=60	SS-316L	15f	10-30 DC	PNP, complementary	-40 85	2,000	100	M12	K1	IIS291	\$167.00
M30, L=70	SS-316L	10f	10-36 DC	PNP, NO	-40 60	50	40	M12	2D,3G	IIS04A	\$223.00
M30, L=70	Metal	12f	10-36 DC	PNP/NPN, NO	-40 85	100	100	M12		IIS920	\$159.00
M30, L=70	Metal	22nf	10-36 DC	PNP/NPN, NO	-25 70	200	100	M12		IIS861	\$167.00
M30, L=72	Metal	15f	10-36 DC	PNP/NPN, NO/NC	-25 70	200	100	M12		IIS860	\$167.00
M30, L=75	Metal	15nf	10-36 DC	PNP, NO	-40 70	100	250	M12		IIS910	\$153.00
M30, L=81	Metal	10f	20-250AC/DC	NO	-25 80	50	250	M12	2m cable	IIO011	\$233.00
M30, L=81	PVC	10f	20-250AC/DC	NO	-25 80	50	250	M12	2m cable	IIO005	\$227.00
F&B Wash-down Applications, IP69K											
M30, L = 59	SS-316L	14	10...36 DC	PNP, NO	0 100	100	100	-	10m cable	IIT206	\$210.00
M30, L=45	SS-316L	15f	10-30 DC	PNP, NO	-40 85	2,000	100	M12	K1	IIS281	\$156.00
M30, L=65	SS-316L	12f	10-30 DC	PNP/NPN, NO/NC	0 100	50	100	M12	IO-Link	IIT244	\$203.00
M30, L=70	SS-316L	22nf	10-36 DC	PNP/NPN, NO	0 100	100	100	M12	FDA	IIT202	\$192.00
M30, L=70	SS-316L	14f	10-36 DC	PNP/NPN, NO	0 100	100	100	M12	FDA	IIT204	\$192.00





Accessories

Type	Description	Order no.	Price
	Angle bracket for type M30, stainless steel	E10737	\$10.00

Inductive sensors

Rectangular Inductive sensors



Size (mm)	Material	Range (mm)	Operating Voltage (V)	Output Function	Temp Range (°C)	Max. Freq'y (Hz)	Max. Load (mA)	Electrical Connection	Note	Article no.	Price
Industrial Applications, IP67											
	40x40x120	20nf	20-250AC/DC	NO/NC	-25 80	20	250	M20		IM0010	\$251.00
	40x40x120	15nf	20-250AC/DC	NO/NC	-25 80	20	250	M20		IM0011	\$251.00
	40x40x66	20	20...250 AC/DC	NO	-25 70	25 (AC)	250 (AC)	M12	AC/DC	IM0054	\$133.00
	40x40x54	20nf	10-36 DC	PNP, NO	-25 70	100	200	M12		IM5115	\$116.00
	40x40x54	35nf	10-36 DC	PNP, NO	-25 70	80	200	M12		IM5116	\$119.00
	40x40x54	40nf	10-36 DC	PNP, NO	-25 70	60	200	M12		IM5117	\$119.00
	40x40x54	20nf	10-36 DC	PNP, NO	-25 70	200	200	M12	K1	IM5119	\$139.00
	40x40x54	40nf	10-36 DC	PNP, Complmtry	-25 70	200	200	M12	K1	IM5126	\$157.00
	40x40x54	40nf	10-36 DC	PNP, Complmtry	-25 70	200	200	M12	K1	IM5135	\$135.00
	40x12x26	2nf	20-250AC/DC	NO	-25 80	80	100	2m Cable		IN0073	\$214.00
	40x12x26	4nf	10-36 DC	PNP, NO	-25 80	1300	250	2m Cable		IN5129	\$147.00
	32x20x8	8f	10-30 DC	PNP, NO	-40 85	400	100	2m Cable		IQ2001	\$165.00
	32x20x8	8f	10-30 DC	PNP, NO	-40 85	400	100	M12 x 0.3m		IQ2002	\$176.00
	32x20x8	8f	10-30 DC	PNP/NPN, NO/NC	-40 85	300	100	M12	IO-Link	IQ2009	\$205.00
	32x20x8	8f	10-30 DC	PNP, NO	-40 85	2000	100	M12		IQ2010	\$161.00
	32x20x8	8f	10-30 DC	PNP, NC	-40 85	2000	100	0.3m, M12		IQ2013	\$172.00
	60x36x10	8f	10-36 DC	PNP, NC	-20 80	300	250	M8, 3W		IW5062	\$165.00
	60x36x10	8f	10-36 DC	PNP, NO	-20 80	300	250	M8, 3W		IW5064	\$179.00
	60x35x20		10-35 DC	PNP, NO/NC	-25 70	35 (m/s)	200	M12	Ring Sensor 10.1mm hole	I7R201	\$320.00

Valve actuator position feedback



Learn more

Continuous position feedback



- Valve Open
- Valve closed
- Warning: valve not completely closed

IO-Link pneumatic valve actuator feedback sensors

Allows the identification of different wear conditions. On the one hand, the sensor features seal monitoring indicating a change of the closed position, which can point to deposits or wear of the seal, for example. On the other hand, the different positions can be counted and the time taken can be measured.

U _v [V DC]	Shaft, height vs dia	Description	Order no.	Price
Smart valve sensor · M12 connector, IP67 protection				
10...30 DC	20mm < 38mm	Smart valve sensor	MVQ101	\$628.00
10...30 DC	20mm < 38mm	Smart valve sensor with solenoid outputs	MVQ201	\$665.00
20...30 DC	20mm < 38mm	Valve sensor with positioning system	MVQ301	\$806.00

Automation package for pneumatic valve actuators



Description	Order no.	Price
Smart valve sensor, MVQ201 installation package		
Mounting footprint 95x50mm, 5/2-way control valve, adjust to 3/2-way	ZZ0628	\$873.00
Mounting footprint 95x50x10mm, 5/2-way control valve adjust to 3/2-way	ZZ0629	\$896.00
Mounting footprint 145x50x10mm, 5/2-way control valve adjust to 3/2-way	ZZ0630	\$907.00
Smart valve sensor, MVQ301 installation package		
Mounting footprint 95x50mm, 5/3-way control valve	ZZ0686	\$1,491.00
Mounting footprint 95x50mm, 3/3-way control valve	ZZ0687	\$1,514.00
Mounting footprint 95x50mm, 5/3-way control valve, defined home position	ZZ0688	\$1,536.00

Accessories



Design	Description	Order no.	Price
	Adapter 80 x 30 x 10 mm	E12569	\$35.00
	Adapter 130 x 30 x 10 mm	E12573	\$51.00
	Mounting bridge shaft height 20...40mm	E12674	\$120.00
	Mounting bridge shaft height 30...50mm	E12628	\$112.00
	2 m black, PUR cable, 5 x 0.34mm	EVC070	\$38.00
	5 m black, PUR cable, 5 x 0.34mm	EVC071	\$47.00
	10 m black, PUR cable, 5 x 0.34mm	EVC072	\$64.00
	2 m black, PUR cable, 5 x 0.34mm	EVC073	\$38.00
	5 m black, PUR cable, 5 x 0.34mm	EVC074	\$47.00

Valve position feedback switches

Dual inductive feedback sensors



Connection	U _i [V]	Output function	IP Rating	Order no.	Price
M12	10...36 DC	2x PNP/NPN - NO	IP67	IN5224	\$325.00
M12	10...36 DC	2x PNP - NO	IP67	IN5225	\$325.00
M12	10...36 DC	2x PNP - NO	IP67	IN5327	\$326.00

Accessories

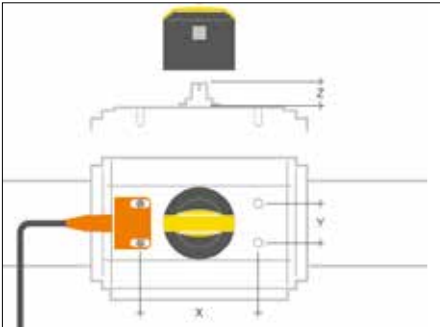

Type	Mounting dimensions [X / Y mm]	Height of the actuator shaft [Z mm]	Shaft diameter	Order no.	Price
	80 / 30	30	Dia. 53 mm	E12517	\$35.00
	80 / 30	30	Dia. 66 mm	E12724	\$42.00

M12 sockets 4-pole (0.34mm sensor)

	2 m black, PUR cable	EVC004	\$35.00
	5 m black, PUR cable	EVC005	\$41.00
	10 m black, PUR cable	EVC006	\$50.00
	25 m black, PUR cable	EVC088	\$89.00

IECEx cables for NN5008

	5 m blue, PUR cable	ENC05A	\$50.00
	10 m blue, PUR cable	ENC06A	\$77.00



Manual Valve Feedback



Type	Description	Top Flange Dia	Order no.	Price
	Manual valve mounting set (F04/M5)	42mm	E12519	\$176.00
	Manual valve mounting set (F05/M5)	50mm	E12520	\$176.00
	Manual valve mounting set (F05/M6)	50mm	E12521	\$176.00
	Manual valve mounting set (F07/M6)	70mm	E12522	\$176.00
	Manual valve mounting set (F07/M8)	70mm	E12523	\$181.00
	Manual valve mounting set (F10/M8)	102mm	E12524	\$194.00

Cylinder sensors T and C slot



Solution builder

Robust connection and mounting system



Conventional sensors:

Cable and mounting screw are placed at opposite ends of the housing. If the cable is pulled, the sensor can be dislodged.

ifm top-loading sensors:





Cable and mounting screw are at the same end. If the cable is pulled, the sensor stays put.

Traditional versus IO-link switches:

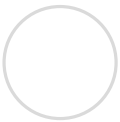
Traditionally two magnetic switches are used for short stroke cylinders. Now one IO-link magnetic switch provides both end outputs. Resulting in a 50% cost reduction!

Smooth Cylinder



Cylinder Type	Type	Description	Order no	Price
Protective Bracket Smooth Cylinders.				
		Outside Ø 11...19 mm. Bore size 10-16 mm	E11975	\$18.00
		Outside Ø 18...29 mm. Bore size 20-25 mm	E11976	\$18.00
		Outside Ø 28...39 mm. Bore size 32 mm	E11977	\$19.00
		Outside Ø 38...49 mm. Bore size 40 mm	E11978	\$19.00
		Outside Ø 48...59 mm. Bore size 50 mm	E11979	\$20.00
		Outside Ø 58...69 mm. Bore size 63 mm	E11980	\$21.00
		Outside Ø 78...89 mm. Bore size 80 mm	E11981	\$22.00
Protective Bracket for Tie-Rod Cylinders				
		Adapter for tie rod / profile cylinders, clamping range 3...7 mm, aluminium	E11913	\$13.00
		Adapter for tie rod / profile cylinders, clamping range 5...7 mm, aluminium	E11912	\$13.00
		Adapter for tie rod / profile cylinders, clamping range 5...11 mm, aluminium	E11797	\$13.00
		Integrated profile thickness diameter 9...15 mm	E11799	\$13.00
		Integrated profile thickness diameter 14...20 mm	E11801	\$15.00

Tie-Rod Cylinder



Cylinder sensors



Magnetic T and C slot

Application	No. Wires	Operating Voltage (V)	Max Switching Freq'y (Hz)	Output	Connection	Order No.	Price
T-Slot, F&B Industry IP69k Types							
Washdown	3	10-30 DC	10,000	PNP NO	0.3m cable M8 plug	MK5111	\$115.00
Washdown	3	10-30 DC	10,000	PNP NO	6m cable	MK5128	\$117.00
Washdown	3	10-30 DC	6,000	PNP NO	0.3m cable M12 plug	MK5157	\$115.00
Washdown	3	10-30 DC	6,000	PNP NO	0.3m cable M12 plug	MK5177	\$115.00

T-Slot, Industrial Cylinder Sensors, IO-link							
Industrial	4	10-30 DC	200	2 x PNP / NPN	2m cable	MK5904	\$207.00
Industrial	3	10-30 DC	200	1 x PNP / NPN	0.3m cable M8 plug, 3 wire	MK5905	\$211.00
Industrial	3	10-30 DC	200	1 x PNP / NPN	0.3m cable M8 plug, 3 wire	MK5906	\$214.00
Industrial	4	10-30 DC	200	2 x PNP / NPN	0.3m cable M8 plug, 4 wire	MK5907	\$214.00
Industrial	4	10-30 DC	200	2 x PNP / NPN	0.3m cable M12 plug	MK5908	\$218.00
Industrial	4	10-30 DC	200	2 x PNP / NPN	6m cable	MK5909	\$219.00

T-Slot, Industrial Cylinder Sensors							
Industrial	3	10-30 DC	10,000	PNP NO	2m cable	MK5100	\$95.00
Industrial	3	10-30 DC	10,000	PNP NO	0.3m cable M8 plug	MK5101	\$101.00
Industrial	3	10-30 DC	10,000	PNP NO	0.3m cable M8 plug	MK5102	\$105.00
Industrial	2	10-30 DC	4,000	PNP/NPN NO	2m cable	MK5103	\$103.00
Industrial	2	10-30 DC	4,000	PNP/NPN NO	0.3m cable M8 plug	MK5104	\$113.00
Industrial	2	10-30 DC	10,000	PNP NO	0.3m cable M12 plug	MK5107	\$108.00
Industrial	3	10-30 DC	10,000	PNP NO	0.3m cable M12 plug	MK5108	\$111.00
Industrial	3	10-30 DC	10,000	PNP NO	6m cable	MK5117	\$108.00
Industrial	2	10-30 DC	4,000	PNP/NPN NO	6m cable	MK5123	\$117.00
Industrial	2	10-30 DC	6,000	NPN NO	0.3m cable M8 plug	MK5137	\$101.00
Industrial	3	10-30 DC	6,000	PNP NO	0.3m cable M8 plug	MK5138	\$101.00
Industrial	3	10-30 DC	6,000	PNP NO	M8 plug	MK5900	\$111.00

T-Slot, AC/DC Versions							
Industrial	2	5-50 AC/DC	1,000	PNP/NPN NO	0.3m cable M8 plug	MR0101	\$63.00
Industrial	3	5-50 AC/DC	1,000	PNP NO	0.3m cable M8 plug	MR0119	\$63.00
Industrial	2	5-50 AC/DC	1,000	PNP/NPN NO	M8 plug	MR0901	\$71.00

C-Slot, Cylinder Sensors							
Industrial	3	10-30 DC	10,000	PNP NO	0.3m cable M8 plug	MK5311	\$121.00

C-Slot, Cylinder Sensors, IO-Link							
Industrial	3	10-30 DC	200	1 x PNP / NPN	2m cable	MK5800	\$221.00
Industrial	3	10-30 DC	200	1 x PNP / NPN	0.3m cable M8 plug	MK5801	\$227.00
Industrial	3	10-30 DC	200	1 x PNP / NPN	0.3m cable M8 plug	MK5802	\$229.00
Industrial	3	10-30 DC	200	1 x PNP / NPN	0.3m cable M12 plug	MK5803	\$229.00
Industrial	3	10-30 DC	200	1 x PNP / NPN	6m cable	MK5804	\$233.00

Motion control sensors and monitors

Precise motion monitoring







Learn more



Inclination Sensor



Type	Description	Order no.	Price
2 axis - IO-Link comms			
	2x Axis. Angular range $\pm 90^\circ$. Output 1 IO-Link NO/NC prog. Output 2 - NO/NC prog. PNP/NPN. Analogue 4...20 mA. Output 3 and 4 analogue	JN2200 	\$773.00
	2x Axis. Angular range $\pm 45^\circ / \pm 90^\circ$, IO-Link. Output 1 - IO-Link NO/NC prog. Output 2 - NO/NC prog. PNP/NPN. Analogue 4...20 mA	JN2201 	\$859.00
1 or 2 axis (X,Y) - CAN bus			
	Inclination sensor; 27 x 59 x 118.5 mm; CAN; Ambient temperature -40...85 °C; M12 Connector; [inclination measurement]: $\pm 90^\circ$	JD2120	\$1,438.00
	Inclination sensor; 27 x 59 x 105.3 mm; CAN; Ambient temperature -40...85 °C; M12 Connector; [inclination measurement]: 0...360 °	JD1111	\$1,392.00

Accessories

Type	Description	Order no.	Price
	2 m black, PUR cable	EVC004	\$35.00
	5 m black, PUR cable	EVC005	\$41.00
	10 m black, PUR cable	EVC006	\$50.00
	25 m black, PUR cable	EVC088	\$89.00

Motion control sensors & controllers

Multi-functional TFT Display for impulse signals, analogue signals & temperature



Power supply	Inputs	Outputs	Order no.	Price
IP65 multi-function TFT display				
24 VDC	V, mA, kHz, °C, PT100, PT1000, thermocouple	2 x relays	DX1063	\$564.00

Rotation & speed monitors



Type	Ub [V]	Setting range [Hz]	Outputs relay	Output	Order no.	Price
Pulse evaluation system with microprocessor for frequency; rotational speed; speed; pulses and machine cycles						
	110...240 AC / 27 (typ. 24) DC 50...60 Hz	0.1...1,000	Analogue out: 1; Relay out: 2	4...20 mA	DD2503	\$783.00



Conversion of pulse sequences into analogue standard signals; pulse evaluation system for frequency, rotational speed, speed, cycles and machine cycles						
	110...240 AC / 24 V DC 50...60 Hz	0.1...1,000	Digital in: 3; out: 2; Analogue out: 1; No of relay out: 2	4...20 mA	DW3003	\$760.00

Type	Installation Range	Setting Range [pulses/min]	Startup delay [s]	Order no.	Price
IO-Link Communication Interface					
M18	7 f	5...24,000	0...30	DI5029	\$296.00
Compact speed monitors					
M18	12 nf	3...6,000	0...15	DI6001	\$550.00
Compact speed monitors, IO-Link					
M18	7 f	1...32,000	0...15	DI6005	\$415.00

Speed monitor with IO-link



Type	Inputs / Outputs	Setting range [Hz]	Output	IP Rating	Order no.	Price
Speed monitor IO-Link - 0...2000 Hz						
	1 x DI 2 x DO	0...2,000	PNP/NPN	IP69K	DP2122	\$326.00
	1 x DI 2 x DO	0...2,000	PNP/NPN	IP69K	DP4122	\$316.00
Counter IO-Link - 0...2000 Hz						
	2x digital PNP	2x digital PNP/NPN	PNP/NPN	IP69K	DP2302	\$332.00
	2x digital PNP	2x digital PNP/NPN	PNP/NPN	IP69K	DP4302	\$320.00

Rotary Encoders, Absolute Encoders Draw Wire Encoders



Learn more



Encoders use the wear-free photoelectric or magnetic detection. A pulse disc firmly attached to the shaft or a movable magnet carrier ensures this detection. A distinction is made between incremental and absolute encoders. Incremental encoders generate a precisely defined number of pulses per revolution. They are a measure of the angular or linear distance moved. Absolute encoders provide an absolute numerical value for each angular position even over several revolutions.

Incremental encoders - 1...10,000 resolution



"Housing Ø [mm]"	"Shaft Ø [mm]"	Design shaft	Flange	Order no.	Price
PerformanceLine 4-digit display, integrated pulse evaluation, 8 core					
58	6	solid shaft	servo	RUP500	\$613.00
58	10	solid shaft	clamp flange	RVP510	\$605.00
58.5	12	hollow shaft	direct	ROP520	\$648.00
58.5	15	hollow shaft	direct	ROP522	\$662.00
58.5	15.875	hollow shaft	direct	ROP524	\$671.00
BasicLine Basic design without display, 5 core					
36.5	6	solid shaft	universal	RB3100	\$445.00
36.5	6	solid shaft	flange	RB3500	\$450.00
36.5	6	hollow shaft	flange	RA3100	\$471.00
58	10	solid shaft	clamp flange	RV3100	\$447.00
58	10	solid shaft	clamp flange	RV3110	\$1,025.00
42	12	hollow shaft	-	RA3101	\$481.00
58.5	12	hollow shaft	direct	RO3100	\$471.00
32.3	12	hollow shaft	flange	RA3110	\$913.00
58.5	15	hollow shaft	direct	RO3102	\$494.00
58.5	15	hollow shaft	direct	RO3110	\$1,114.00

Absolute encoders draw wire encoders

Wire Length	Connector	Description	Output	Order no.	Price
1.9 m	M12	8,192 steps; 16 revolutions; 17 bit	4...20	RMS001	\$1,379.00
3.0 m	M12	8,192 steps; 16 revolutions; 17 bit	4...20	RMS002	\$1,819.00
10.0 m	M12	4,096 steps; 4,096 revolutions; 24 bit	CANopen	RMS005	\$3,391.00

Rotary encoders

Absolute multi-turn encoders



"Housing Ø [mm]"	"Shaft Ø [mm]"	Flange	Resolution	Order no.	Price
Absolute position traceability					
58	10	clamp	15/16 bits	RMV300	\$1,253.00
36.5	12	direct	15/16 bits	RMA300	\$1,312.00
58	15	hollow	15/16 bits	RMO300	\$1,325.00

Draw-wire



Length	Shaft Ø	Design shaft	Max Speed	Order no.	Price
1.9 m	6 mm	solid shaft	2.0 m / sec	E61439	\$690.00
2.4 m	6 mm	solid shaft	1.0 m / sec	E61440	\$946.00
3.0 m	6 mm	solid shaft	0.8 m / sec	E61441	\$1,226.00
5.0 m	6 mm	solid shaft	2.0 m / sec	E61442	\$1,737.00

Accessories

Type	Description	Order no.	Price
M12 sockets 8-pole			
	5 m, 8-pole, black, PUR cable	E12403	\$108.00
	10 m, 8-pole, black, PUR cable	E12404	\$139.00
	5 m, 5-pole, black, TPU cable	EVC545	\$58.00
	10 m, 5-pole, black, TPU cable	EVC546	\$78.00
	Flexible coupling with adjusting screws, Ø 10 mm / 10 mm, aluminium	E60022	\$114.00
	Flexible coupling with clamp connection, Ø 10 mm / 10 mm, aluminium	E60067	\$113.00
	Flexible coupling with clamp connection, Ø 6 mm / 10 mm, aluminium	E60066	\$113.00
	Angle bracket RU,RN,RM,RMU	E60034	\$148.00
	Angle bracket encoders RV,RMV	E60035	\$148.00
	Spring arm	E61438	\$470.00
	Aluminium surface measuring wheel External diameter 63.6 mm	E60095	\$134.00
	Aluminium surface measuring wheel External diameter 159.15 mm	E60098	\$160.00
	Rubber surface measuring wheel External diameter 63.66 mm	E60138	\$134.00
	Rubber surface measuring wheel External diameter 159.15 mm	E60110	\$160.00



Capacitive sensors

Detection through non-metallic material



Learn more

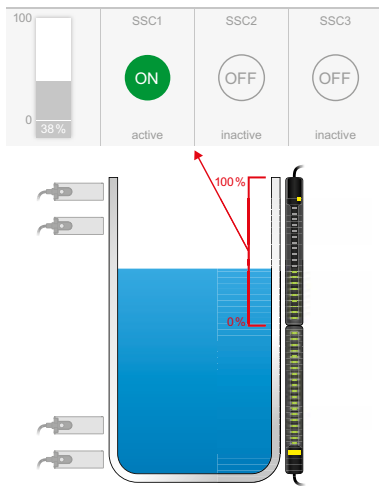

- Continuous level monitoring from outside the process
- No stress caused by the medium thanks to non-contact detection
- Three point level positions in one sensor
- ✔ Deposits can be detected and signalled to improve quality of the process
- ✔ Several KQ10 units can be linked via IO-Link

KQ10 for continuous Level monitoring - 3 programmable set points



Type	Power Supply	Ambient temp	Protection rating	Connection	Order no.	Price
Capacitive point level via continuous level monitoring - PNP/NPN						
	18-30 vDC	20...80°	IP67	2m cable, 5-pole	KQ1000	\$584.00
	18-30 vDC	-20...80°	IP67	0.1m cable, M12 connector, 5-pole	KQ1001	\$584.00

Accessories

Type	Description	Order no.	Price
	Mounting adapter for flat surfaces	E12675	\$55.00
	Mounting adapter for pipes	E12676	\$52.00
	Surface mount tape for KQ10	E12677	\$104.00
	PA cable tie, 760mm long (5 piece pack)	E10880	\$14.00
	2m, Black, PUR jumper, 5-pole	EVC058	\$73.00
	5m, Black, PUR jumper, 5-pole	EVC059	\$84.00

Capacitive sensors

PROGRAMMABLE RANGES



Design	Power Supply	Output	Sensing range [mm]	Housing material	Order no.	Price
Performanceline · M12 connector · 3 wires, IO-Link Com 2						
M12	10...36 VDC	PNP, NO	1...6 f	SS316S12	KF5001	\$287.00
M12	10...36 VDC	PNP, NO	3...12 nf	SS316S12	KF5002	\$287.00
M18	10...36 VDC	PNP, NO/NC	5...30 nf	PBT	KG6000	\$263.00
M30	10...36 VDC	PNP, NO/NC	5...40 nf	PBT	KI6000	\$263.00
M30	20...250 AC/DC	NO/NC Prog	5...40 nf	PBT	KI0054	\$323.00
M30	10...36 VDC	PNP, NO/NC	8 f	SS316S12	KI5085	\$324.00
M30	10...36 VDC	PNP, NO/NC	15 nf	SS316S12	KI5087	\$324.00
M30	NAMUR	NC	15 nf	PBT	KI5031	\$315.00



Accessories

Type	Description	Order no.	Price
	Mounting adapter for M30 types, G 1 1/2", POM, gasket EPDM	E11033	\$102.00
	2 m black, PUR cable	EVC004	\$35.00
	5 m black, PUR cable	EVC005	\$41.00
	10 m black, PUR cable	EVC006	\$50.00
	25 m black, PUR cable	EVC088	\$89.00

Type KQ point level sensors



Capacitive sensors in small plastic rectangular housing. Easy installation with mounting adapters and fixing straps.

Design	Output stage	Sensing range [mm]	Housing material	Connection	Order no.	Price
Performanceline · M12 connector · 3 wires, IO-Link Com 2						
48 x 20 x 7	PNP	12 nf	PBT	cable 2 m	KQ5100	\$119.00
Connection cable with M12 connector · 3-wire						
48 x 20 x 14		12 nf	PBT	M12	KQ6005	\$230.00

Multi coloured touch sensors with IO-Link



Housing material	Electrical design	Ambient temp	Protection rating	Connection	Order no.	Price
Multi-coloured touch sensors with IO-Link						
Plastic PA	PNP/NPN, NO/NC programmable	-30...65°	IP69K	M12	KTE101	\$154.00
Plastic PA	PNP/NPN, NO/NC programmable	-30...65°	IP69K	2m PUR cable	KTE102	\$177.00
SS304	PNP/NPN, NO/NC programmable	-30...65°	IP69K	M12	KTE301	\$203.00
SS304	PNP/NPN, NO/NC programmable	-30...65°	IP69K	2m PUR cable	KTE302	\$187.00

Note: refer to the ifm.com/au order number / accessories - to purchase symbol discs and surrounds.

Photoelectric sensors overview

Application Selection Guide



		Function Principle	Range
	O8 series & Fibre Optics Miniature design, infrared and red light sensors	Retro-Reflective	0...1.8m
		Through-Beam	0...3m
	O6 Series Compact rectangular plastic housing Wetline for Hygienic Wet Areas	Diffuse	0...0.5m
		Retro-Reflective	0...5m
		Through-Beam	0...10m
	OF & OG Series M12 & M18 Threaded for Wet Areas M18 Cube in Metal housing	Diffuse	0...1.5m
		Retro-Reflective	0...15m
		Through-Beam	0...60m
	O1D, OID, OGD Series PMD Distance Sensor for Precise Measurement	Diffuse	0...1.5m
	O5/O4 Series Rectangular design for industrial applications	Diffuse	0...2m
		Retro-Reflective	0...10m
		Through-Beam	0...25m
	PMD Profiler Precise contour monitoring	Diffuse	150...300m
	Light Grid for interlogistics Safety Light Curtains and Grids		20m
	UG Series Object Detection for transparent targets	Diffuse	0.03...8.0m
	2D & 3D Vision Solutions	Diffuse	4 m

Correct selection of Optical Sensor Outputs

MODE	LIGHT ON	DARK ON	MODE	LIGHT ON	DARK ON
Diffuse 			DIFFUSE	OUTPUT ON 	OUTPUT ON
				OUTPUT OFF 	OUTPUT OFF
Retroreflective 			RETRO-REFLECTIVE	OUTPUT ON 	OUTPUT ON
				OUTPUT OFF 	OUTPUT OFF
Thru-Beam 			THRU-BEAM	OUTPUT ON 	OUTPUT ON
				OUTPUT OFF 	OUTPUT OFF

Photoelectric sensors & mounting accessories



Learn more

Fibre optic sensors, select fibre optics from "Accessories"



Connection	Output Function	Switching frequency [kHz]	Order no.	Price
Operating Range [mm] up to 1.25m (diffuse), 2m through beam				
Cable 2.0 m	2 x PNP/NPN (prog)	max. 20	OCF500	\$394.00
M8	2 x PNP/NPN (prog)	max. 20	OCF501	\$394.00
M12 pigtail	2 x PNP/NPN (prog)	max. 20	OCF502	\$394.00

O8 Series miniature plastic - best background suppression available!



Miniature sensors, short range

Note: BGS = Background Suppression

Range	Connection	Order no.	Price
Diffuse reflection sensor with background suppression · 24 vDC, PNP IO-Link			
15mm	0.3 m PVC cable / M8 connector, 3 poles, light on	O8H202	\$251.00
30mm	2 m PVC cable, 3 poles, light on	O8H206	\$251.00
50mm	2 m PVC cable, 3 poles, programmable LO/DO	O8H212	\$251.00
50mm	0.3 m PVC cable / M8 connector, 3 poles, light on	O8H214	\$251.00
80mm	2 m PVC cable, 3 poles, light on	O8H218	\$251.00
80mm	0.3 m PVC cable / M8 connector, 3 poles, light on	O8H222	\$251.00
80mm	0.3 m PVC cable / M12 connector, 4 poles, light on	O8H273	\$251.00
Retro reflective sensor · 3 wires 24 vDC, PNP IO-Link			
1.8m	2 m PVC cable, 3 poles	O8P200	\$217.00
1.8m	0.3 m PVC cable / M8 connector, 3 poles	O8P202	\$217.00
1.8m	0.3 m PVC cable / M8 connector, 3 poles	O8P204	\$217.00
Through beam transmitter · 2 wires 24 vDC, PNP, IO-Link,			
1.8m	0.3 m PVC cable / M8 connector, 2 poles	O8S201	\$151.00
Through beam receiver · 3 wires 24 vDC, PNP, IO-Link			
1.8m	0.3 m PVC cable / M8 connector, 3 poles, PNP, LO/DO, Prog	O8E202	\$176.00



Whether flat, shiny, matte, dark or light, the O8 offers reliable optical performance independent of target color and is ideal for assembly automation and robotic applications.

Type	Description	Order no.	Price
	O8 Standard Angle L-bracket	E21291	\$20.00
	O8 Clamp Bracket 10 mm	E21298	\$45.00
	Rod Mounting Straight D10mm	E21081	\$27.00
	Prismatic reflector Ø 50 mm, plastic	E20004	\$15.00
	Prismatic reflector Ø 80 mm, plastic	E20005	\$17.00
	Prismatic reflector 48 x 48 mm, PMMA, ABS	E20744	\$35.00
	Mounting set for reflector E20744, clamp mounting, SS, 61 x 51 mm	E20724	\$10.00
	Adjustable mounting set,	E20950	\$25.00
	Mounting cube (for aluminium profiles)	E20951	\$25.00

Photoelectric sensors

O6 Series IP67, photoelectric sensors



* at maximum range.
 ** referred to prismatic reflector Ø 80 mm
 *** 4-wire, complementary output
 # infrared



Easy alignment – Powerful visible red light source with precise spot enables easy alignment and quick setup.

Range [mm]	Light spot dia [mm]	Connector	Order no.	Order no.	Price
Diffuse reflection sensor · 3-wire DC, programmable output			PNP	NPN	
2...200	8*	M12, 3-pole (BGS)	O6H201	-	\$233.00
2...200	8*	M8, 3-pole (BGS)	O6H202	-	\$233.00
25...400	200*	M8, 4-pole	O6W202	-	\$341.00
5...500	15*	M8, 3-pole	O6T202	O6T206	\$203.00
5...600	24*	M8, 4-pole	O6T215#	O6T216#	\$203.00
Retro-reflective sensor polarisation filter · 3-wire DC			PNP	NPN	
50...5,000	150**	M12, 3-pole	O6P201	O6P205	\$203.00
50...5,000	150**	M8, 3-pole	O6P202	O6P206	\$203.00
50...5,000	150**	M8, 4-pole	O6P203	O6P207	\$203.00
Through-beam sensor transmitter · 2-wire DC					
0...10,000	300*	M8, 3-pole	O6S202		\$106.00
Through-beam sensor receiver · 3-wire DC			PNP	NPN	
0...10,000		M8, 3-pole	O6E202	O6E206	\$129.00

Type	Description	Order no.	Price
Prismatic reflector			
	Ø 50 mm, plastic, -10...60° C	E20956	\$18.00
	Ø 80 mm, plastic, -10...60° C	E20005	\$17.00
	48 x 48 mm, PMMA, ABS, -10...60° C	E20744	\$35.00
	Reflector mounting bracket E20744, SS, 61 x 51 mm	E20724	\$10.00
	Adjustable mounting set,	E20946	\$35.00
	Mounting cube for aluminium profiles	E20951	\$25.00
	96 x 96 mm, plastic, -10...60° C	E20454	\$38.00
	Reflector mounting bracket E20454, SS, 100 x 100 mm	E20935	\$63.00

O6 Series High Precision Laser Sensors



Range [mm]	Laser class	Connection	Frequency [Hz]	Order no.	Price
IO-Link, diffuse sensor with high excess gain (HEG) feature					
0...100	1	M12, 0.3m pigtail	max. 1,000	O6H701	\$447.00
Retro-reflective sensor with polarisation filter, 3-wire DC (reflector E20722)					
75...8,000	1	M12, 0.3m pigtail	max. 1,000	O6P701	\$419.00
Through-beam sensor transmitter, DC					
15,000	1	2m cable, 3-pole	max. 1,000	O6S700	\$337.00
15,000	1	M12, 0.3m cable, 4-pole	max. 1,000	O6S701	\$337.00
Through-beam sensor receiver, 3-wire DC					
15,000	1	M12, 0.3m cable, 4-pole	max. 1,000	O6E701	\$213.00

Photoelectric sensors

O6 Series IP69K, photoelectric sensors



IP 67
IP 68
IP 69 K

High-grade stainless steel

* at maximum range.
** referred to prismatic reflector Ø 80 mm
*** 4-wire, complementary output



Range [mm]	Light spot dia [mm]	Connector	Order no.	Order no.	Price
Diffuse reflection sensor · 3-wire DC, programmable output			PNP	NPN	
2...200	8*	2m PVC cable (BGS)	O6H300 ⚡	-	\$331.00
2...200	8*	M12, 3-pole (BGS)	O6H301	-	\$331.00
2...200	8*	M8, 4-pole (BGS)	O6H303	O6H307	\$331.00
2...200	8*	M8, 4-pole (BGS)	O6H309 ⚡	-	\$343.00
5...500	15*	M12, 4-pole	O6T301	O6T305	\$287.00
5...500	15*	M8, 4-pole	O6T309 ⚡	-	\$299.00
Retro-reflective sensor polarisation filter · 3-wire DC			PNP	NPN	PNP
50...5,000	150**	M12, 4-pole	O6P301	O6P305	\$301.00
50...5,000	150**	M8, 3-pole	O6P302	O6P306	\$301.00
50...5,000	150**	M8, 4-pole	O6P303	-	\$301.00
50...5,000	150**	M8, 4-pole	O6P309	-	\$309.00
50...5,000	150**	M8, 4-pole***	O6P310	-	\$296.00
Through-beam sensor transmitter · 2-wire DC			PNP	NPN	PNP
0...10,000	300*	M12, 4-pole	O6S301	-	\$171.00
0...10,000	300*	M8, 3-pole	O6S302	-	\$171.00
0...10,000	300*	M8, 4-pole	O6S303	-	\$171.00
0...10,000	300*	M8, 4-pole	O6S305 ⚡	-	\$182.00
Through-beam sensor receiver · 3-wire DC			PNP	NPN	PNP
-	-	2m PVC cable	O6E300	-	\$203.00
-	-	M12, 4-pole	O6E301	O6E305	\$203.00
-	-	M8, 3-pole	O6E302	O6E306	\$203.00
-	-	M8, 4-pole	O6E303	-	\$203.00
0...10,000	-	M8, 4-pole	O6E309 ⚡	-	\$213.00

Type	Description	Order no.	Price
Solidchem Prismatic reflectors for the food industry (up to 140° C)			
	56 x 38 mm	E21268	\$39.00
	46 x 48 mm	E21269	\$62.00
	96 x 96 mm	E21270	\$88.00
	Bracket for free-standing mounting, stainless steel	E21271	\$18.00
	Mounting set for clamp mounting, stainless steel, Ø 10 mm	E21272	\$45.00
	Mounting set for clamp mounting, stainless steel, Ø 12 mm	E21275	\$43.00
	Adjustable mounting set	E20716	\$15.00
	Mounting cube (for aluminium profiles)	E20951	\$25.00
	Mounting rod, 120 mm, Ø 10 mm, M8 thread, stainless steel	E21081	\$27.00
	Mounting rod, 100 mm, Ø 12 mm, M10 thread, stainless steel	E20938	\$17.00

ifm electronic

ECOLAB
The Global Leader in Laboratory
Purity and Sanitation Solutions

ECOLAB Deutschland GmbH
Ecolab-Allee 1
D-40785 Monheim am Rhein

certifies that for
ifm electronic gmbh
Friedrichstraße 1
45128 Essen

a
material resistance test
was performed with P3-topax 19, P3-topax 56,
P3-topax 66, P3-topax 990, P3-topactive 200,
P3-topactive DES and demineralised water as
zero value.

The material compatibility of the tested sensors
from the serie O6e3xx with the P3 products used
in the test can be considered to be positive
under the operating conditions stated overleaf.

Monheim, 19 August 2014

i.v. T. Tybonki

i.v. R. Lauff

Photoelectric sensors

M18 OG-cube series - standard applications, zinc alloy body



Range	Light-on / dark-on mode	Switching output	Order no.	Order no.	Price
Diffuse reflection sensor with BGS · M12 connector · 3 wires			PNP	NPN	
15...200 mm	programmable	24v DC PNP	OGH580 ☺	-	\$323.00
100 mm (fixed)	Light On	24v DC PNP	OGH280 ☺	-	\$303.00
200 mm (fixed)	Light On	24v DC PNP	OGH281 ☺	-	\$303.00
200 mm (fixed)	Light On	24v DC NPN	-	OGH283 ☺	\$297.00
Retro-reflective sensor with polarisation filter · M12 connector · 3 wires					
100 mm...4 m	Dark On	24v DC PNP	OGP280 ☺	-	\$269.00
100 mm...4 m	Dark On	24v DC NPN	-	OGP282 ☺	\$264.00
100 mm...4 m	Light On	24v DC PNP	OGP281 ☺	-	\$269.00
Through beam sensor					
15 m	-	Transmitter	OGS280 ☺	-	\$182.00
15 m	Dark On	Receiver	OGE280 ☺	-	\$231.00
15 m	Light On	Receiver	OGE281 ☺	-	\$231.00



Robust metal housings

ifm's OG Series photoelectrics are far more robust than cheap plastic housings, which suffer from stripped mounting threads over time and the M12 connectors are a weak point that lead to maintenance problems!



M18 OG-cube series - IP69k applications, stainless steel body



Range	Light-on / dark-on mode	Switching output	Order no.	Order no.	Price
Diffuse reflection sensor with BGS · M12 connector · 3-wire DC			PNP	NPN	
100 mm (fixed)	light-on	24v DC PNP	OGH380 ☺	-	\$312.00
200 mm (fixed)	light-on	24v DC PNP	OGH381 ☺	-	\$312.00
Through-beam sensor - transmitter · M12 connector			PNP	NPN	
15 m	-	-	OGS380 ☺	-	\$218.00
Through-beam sensor - receiver · M12 connector · 3 wires			PNP	NPN	
15 m	dark-on	24v DC PNP	OGE380 ☺	-	\$241.00
15 m	light-on	24v DC PNP	OGE381 ☺	-	\$241.00

IP 67
IP 68
IP 69 K

High-grade stainless steel

Vibration and shock resistant

Photoelectric sensors

M18 OG Series - stainless steel body



Bracket system offers accurate alignment



Innovative mounting brackets offer quick installation and setup. The bracket rotates 360° in each of two axes to achieve the most accurate alignment.

Range [mm]	Light-on / dark-on mode	Protection	Function	Order no.	Price
Diffuse reflection sensor, M12 connector - 3-wire DC					
100	PNP, Light On	IP69k	Background suppression	OGH300	\$339.00
250	PNP, Light On	IP65	Background suppression	OGH200	\$302.00
300	PNP, Prog LO/DO	IP69k	Background suppression	OGH312	\$354.00
300	PNP, Prog LO/DO	IP67	Background suppression	OGH500	\$323.00
300	NPN, Prog, LO/DO	IP67	Background suppression	OGH504	\$332.00
25...400	PNP, Prog LO	IP 65	Background suppression	OGW202	\$382.00
600	PNP, Light On	IP65	-	OGT200	\$220.00
800	PNP, Prog LO/DO	IP69k	-	OGT300	\$296.00
800	PNP, Prog LO/DO	IP67	-	OGT500	\$240.00
Retro reflective sensor, M12 connector - 3-wire DC					
4,000	PNP, Dark On	IP69K	-	OGP300	\$308.00
4,000	PNP, Light On	IP69K	-	OGP301	\$308.00
4,000	PNP, Dark On	IP67	-	OGP200	\$270.00
4,000	PNP, Light On	IP67	-	OGP201	\$270.00
5,000	PNP, Prog LO/DO	IP67	-	OGP500	\$302.00
Through-beam sensor, M12 connector - 3-wire DC					
20,000	PNP, Dark On	IP67	Receiver	OGE200	\$235.00
20,000	-	IP67	Transmitter	OGS200	\$192.00
20,000	PNP, Dark On	IP69K	Receiver	OGE300	\$272.00
20,000	PNP, Light On	IP69K	Receiver	OGE301	\$272.00
20,000	-	IP69K	Transmitter	OGS300	\$228.00
20,000	PNP, Prog LO/DO	IP69K	Receiver	OGE500	\$261.00
20,000	-	IP69K	Transmitter	OGS500	\$216.00

Accessories

Type	Description	Order no.	Price
	Clamp for Free-standing M10, capscrew, high-grade stainless steel	E20870	\$43.00
	Clamp for mounting rod Ø 12 mm, high-grade stainless steel	E21206	\$35.00
	Mounting rod, 100 mm, Ø 12 mm, M10 thread, stainless steel	E20938	\$17.00
	Mounting cube (for aluminium profiles)	E20951	\$25.00
	Prismatic reflector, Ø 80 mm, plastic	E20005	\$17.00
	48 x 48 mm, PMMA, ABS	E20744	\$35.00
	96 x 96 mm, plastic	E20454	\$38.00

Photoelectric sensors

M12 OF series - Industrial applications



Range [mm]	Light-on / dark-on mode	Protection	Function	Order no.	Price
Diffuse reflection sensor, M12 connector · 3-wire DC PNP					
200	Prog LO/DO	IP67	-	OF5010	\$329.00
200	Prog LO/DO	IP65	-	OF5012	\$363.00
400	Prog LO/DO	IP65	-	OF5027	\$363.00
Through beam sensor, M12 connector · 3-wire DC PNP					
4,000	-	IP65	Transmitter	OF5021	\$247.00
4,000	Prog LO/DO	IP65	Receiver	OF5022	\$291.00

05 Series long range photoelectrics



Standard applications

Ranges [mm]	Spot Ø at max. range [mm]	Light-on / dark-on	Output function	Order no.	Price
Diffuse reflection sensor with BGS · M12 connector · 3-wire DC					
50...1,400	50	Light On	PNP	O5H200	\$337.00
50...1,800	50	Prog LO/DO	PNP	O5H500	\$441.00
Retro-reflective sensor · red light 624 nm · M12 connector · polarisation filter					
75...10,000	250	Prog LO/DO	PNP	O5P500	\$337.00
Through-beam sensor - transmitter · M12 connector					
0...25,000	625	Prog LO/DO	Transmitter	O5S500	\$261.00
0...25,000	-	Prog LO/DO	Receiver (PNP)	O5E500	\$332.00
Contrast sensor, M12 connector · 3-wire DC PNP / NPN					
18...22	1.5 x 5	Prog LO/DO	PNP/NPN	O5K500	\$643.00
Glass sensor, M12 connector · 3-wire DC PNP / NPN					
0...3,000	80	Prog LO/DO	PNP/NPN	O5G500	\$470.00



Accessories

Type	Description	Order no.	Price
	Universal angle bracket	E21085	\$37.00
	Mounting set for clamp mounting, high-grade stainless steel, diecast zinc clamp	E21211	\$18.00
	Mounting set for clamp mounting, high-grade stainless steel	E21212	\$33.00
	Clamp for mounting rod, Ø 12 mm, diecast zinc	E20717	\$15.00
	Clamp for mounting rod, Ø 12 mm, high-grade stainless steel	E21110	\$25.00
	Mounting rod, 100 mm long, Ø 12 mm, M10 thread, stainless steel	E20938	\$17.00
	Mounting cube (for aluminium profiles)	E20951	\$25.00
	Mounting rod, 200 mm, Ø 12 mm, M10 thread, stainless steel	E20940	\$51.00
	Prismatic reflector 48 x 48 mm, plastic	E20744	\$35.00
	Prismatic reflector Ø 42 mm, plastic	E20004	\$15.00
	Prismatic reflector Ø 80 mm, plastic	E20005	\$17.00

Innovative 'Teach Mode' operation



Step 1: OUT-off

Mount and align the sensor in the application. The sensor's visible red light simplifies adjustment. Press the OUT-off (output off) button for two seconds.



Step 2: OUT-on

Position the object to be detected. Press the OUT-on (output on) button. The sensor is now ready for operation.

Laser sensors

M18 OG-cube series - Lasers

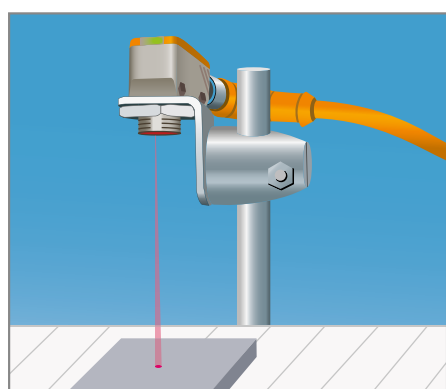

Range [mm]	Housing material	Output	Connection	Article no.	Price
Mid range laser distance sensor - M12 connector					
50...2,000	Plastic	2x PNP/NPN Programmable, target reflectivity	M12, 4-pole	OGD250	\$642.00
50...2,000	Plastic	1x PNP/NPN 1x Analogue, target reflectivity	M12, 4-pole	OGD251	\$688.00
50...2,000	316 SS	2x PNP/NPN Programmable, target reflectivity	M12, 4-pole	OGD550	\$780.00
50...2,000	316 SS	1x PNP/NPN 1x Analogue, target reflectivity	M12, 4-pole	OGD551	\$826.00
50...4,000	316 SS	2x PNP/NPN	M12, 4-pole	OGD560	\$780.00

Accessories

Type	Description	Article no.	Price
	Clamp for Free-standing M10, capscrew, high-grade stainless steel	E20870	\$43.00
	Clamp for mounting rod Ø 12 mm, high-grade stainless steel	E21206	\$35.00
	Mounting rod, 100 mm, Ø 12 mm, M10 thread, stainless steel	E20938	\$17.00
	Prismatic reflector, Ø 80 mm, plastic	E20005	\$17.00
	48 x 48 mm, PMMA, ABS	E20744	\$35.00
	96 x 96 mm, plastic	E20454	\$38.00

High performance background suppression

The OG background suppression sensor uses diode array technology that enables the sensor to differentiate between the target and the background regardless of background color.

High precision laser sensor measures distances in the µm range



Range	Resolution	Outputs	Article no.	Price
30...80 mm	0.01 mm	0.5 2x PNP/NPN (selectable)	OMH550	\$1,316.00
30...80 mm	0.01 mm	0.5 1x PNP/NPN 1x analogue	OMH551	\$1,364.00
50...200 mm	0.05 mm	1 2x PNP/NPN (selectable)	OMH552	\$1,316.00
50...200 mm	0.05 mm	1 1x PNP/NPN 1x analogue	OMH553	\$1,364.00
50...500 mm	0.5 mm	1 2x PNP/NPN (selectable)	OMH554	\$1,316.00
50...500 mm	0.5 mm	1 1x PNP/NPN 1x analogue	OMH555	\$1,364.00

Laser sensors

OG Series Laser Sensor, with precise background suppression



Range [mm]	Laser class	Outputs	Protection	Order no.	Price
M18 design, M12 connector, PNP programmable output					
20...200	1	DC PNP	IP67	OGH700	\$576.00
20...200	1	DC NPN	IP67	OGH701	\$576.00
200...15m	1	DC PNP	IP67	OGP700	\$571.00
60m	1	Transmitter, DC PNP	IP67	OGS700	\$443.00
60m	1	Receiver, DC PNP	IP67	OGE700	\$305.00

OI Series Laser Sensors with background suppression



Range [mm]	Laser class	Outputs	Protection	Order no.	Price
M30 design, (with setting ring) M12 connector, complementary output					
30...2,000	2	DC PNP, IO-Link prog	IP67	OID200 ☼	\$481.00
30...2,000	1	DC PNP, IO-Link prog	IP67	OID250 ☼	\$481.00
M30 design, M12 connector, complementary output					
30...2,000	2	DC PNP, IO-Link prog	IP69K	OID204 ☼	\$476.00
30...2,000	1	DC PNP, IO-Link prog	IP69K	OID254 ☼	\$476.00

O6 Series High Precision Laser Sensor



Range [mm]	Laser class	Frequency [Hz]	Protection	Order no.	Price
O6 design, M8 connector, new high excess gain (HEG) feature					
30...3,000	1	max. 140	IP67	O6D100 ☼	\$529.00

O5 Series Laser Sensors



Range [mm]	Laser class	Outputs	Order no.	Price
O5 design, M12 connector, complementary output (class 2 laser)				
30...2,000	2	DC PNP, IO-Link prog	O5D100 ☼	\$478.00
30...2,000	2	DC NPN, IO-Link prog	O5D102 ☼	\$478.00
O5 design, M12 connector, complementary output (class 1 laser)				
30...2,000	1	DC PNP, IO-Link prog	O5D150 ☼	\$478.00

Accessories

Type	Description	Order No.	Price
	Mounting set Ø 30.2 mm, clamp mounting, material die cast zinc	E20873	\$20.00
	Mounting set Ø 30.2 mm, clamp mounting, high-grade stainless steel	E20874	\$43.00
	2 m black, PUR cable	EVC001	\$35.00
	5 m black, PUR cable	EVC002	\$41.00
	2 m black, PUR cable	EVC004	\$35.00
	5 m black, PUR cable	EVC005	\$41.00

CLASS 1
LASER
PRODUCT
IEC60825-1:2007
IEC60825-1:2014
21CFR PART1040

Class 1
Laser



Class 2
Laser

Laser sensors

O1D Series Laser distance sensors

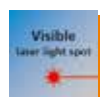

Range [mm]	Laser class	Outputs	Sample rate	Order no.	Price
Long Distance laser sensor					
200...10,000...10V	2	PNP + 4...20 mA / 0	1...50 Hz	O1D100	\$861.00
200...10,000	2	DC 1 x PNP	1...5 Hz	O1D101	\$861.00
200...10,000	2	2 x PNP or 4...20 mA / 0...10V	1...33 Hz	O1D105	\$861.00
300...6,000	1	2 x PNP or 4...20 mA / 0...10V	1...33 Hz	O1D155	\$861.00
200...10,000	2	DC PNP, IO-Link prog	1...50 Hz	O1D120	\$861.00
Level detection					
200...10,000..		2 x PNP or 4. 20 mA / 0...10V	1...33 Hz	O1D300	\$869.00
Retro-reflective distance detection					
75m	2	2 x PNP + 4...20 mA / 0 ...10V	1...33 Hz	O1D106	\$944.00
Use with Retro-Reflector 226 x 262 mm				E21159	\$272.00



The sensor's 4-digit alphanumeric display precisely indicates the measured distance. Models available with simple teach function or parameter setup via pushbutton.

Type	Description	Order No.	Price
	O1D Alignment + Mounting adapter SS316L	E2D101	\$66.00
	O1D alignment swivel bracket complete with M10-Ø12mm x 130mm long mounting pole, SS316L	E21079	\$105.00
	Process flange adapter G1 for O1D	E21224	\$353.00
	Plastic cover for O1D	E21133	\$69.00
	Glass cover for O1D	E21171	\$79.00
	Cooling box / Protective cover	E21248	\$671.00
	2 m black, PUR cable	EVC001	\$35.00
	5 m black, PUR cable	EVC002	\$41.00
	10 m black, PUR cable	EVC003	\$50.00
	25 m black, PUR cable	EVC084	\$89.00
	2 m black, PUR cable	EVC004	\$35.00
	5 m black, PUR cable	EVC005	\$41.00
	10 m black, PUR cable	EVC006	\$50.00
	25 m black, PUR cable	EVC088	\$89.00

Measuring light grids for object monitoring in intralogistics



Learn more

Photoelectric sensors



- **Simple object dimensioning in intralogistics without complex programming.**
- **High resolution for precise object detection.**
- **Ease of integration due to a standardised IO-Link interface.**
- **Selective evaluation of beams to determine the dimensions or distances between objects.**



For optimised logistic processes

The measuring light grids are perfectly suitable for monitoring intralogistics processes. An evaluation of how many and which light beams are obstructed is provided and can be used to detect whether the conveyed objects are in the correct and safe transport position. With a beam distance of 10 millimetres, the height and width of pallets, packages and boxes, too, can be precisely detected.

Precise monitoring with IO-Link

Five different measured values in total can be transmitted via IO-Link using the multi-beam system. The height, position, but also the contour of one or several objects can be derived from these values. What is more, diagnostic information on operating hours are determined and transmitted digitally for needs-based maintenance.



Products

Height Light grids [mm]	Height Measuring range [mm]	Number of beams	Order no.	Price
Measuring light grids with IO-Link				
213	140	15	OY5100	\$1,608.00
663	590	60	OY5103	\$3,167.00
1113	1040	105	OY5106	\$4,751.00
1713	1640	165	OY5110	\$6,762.00
2163	2090	210	OY5113	\$8,295.00
2613	2540	255	OY5116	\$10,203.00

Common technical data

Operating voltage [vDC]	24 +/- 20%
Ambient temperature [°C]	-10...55
Max. range*[m] (distance from transmitter to receiver)	10
Protection rating, Protection class	IP 65 / IP 67 III
Type of light	infrared
Distance of beams [mm]	10
Output**	PNP / NPN
Output H = light-on / D = dark-on mode	H / D

* with Y splitter cable EY5053, ** switchable via IO-Link

Accessories

Design	Description	Order no.	Price
Mounting accessories			
	Mounting and fine adjustment unit	EY3013	\$103.00
	Adjustable brackets	EY3004	\$65.00
	Laser adjustment aid	EY3099	\$1,101.00
	USB IO-Link master set	ZZ1060	\$633.00
Connection technology			
	Socket, M12, 5 poles 1 m, black, PUR cable	EVC196	\$34.00
	Socket, M12, 5 poles 2 m, black, PUR cable	EVC070	\$38.00
	Socket, M12, 5 poles 5 m, black, PUR cable	EVC071	\$47.00
	Socket, M12, 5 poles 10 m, black, PUR cable	EVC072	\$64.00
	Y splitter cable Range: 1...10 m	EY5053	\$91.00
	Y splitter cable Range: 0...2 m	EY5054	\$91.00

Functional principle

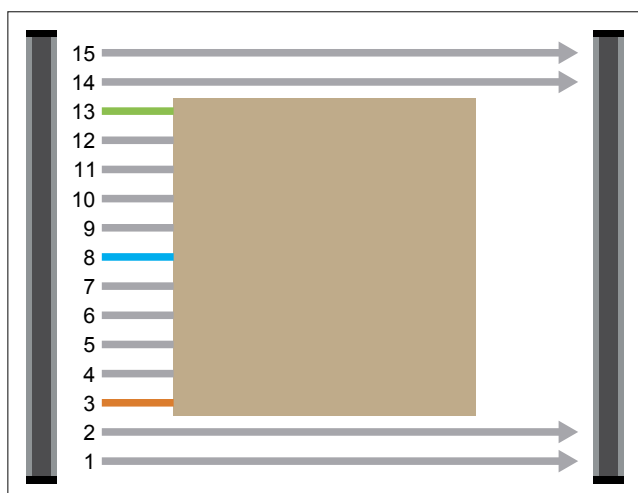

Multi-beam system with 5 measured values

The five different measured values in total are used to derive the height, position and but also the contour of one or several objects.



FBO	First beam occupied:	3
LBO	Last beam occupied:	13
CBO	Central beam occupied:	8
NBO	Number of beams occupied:	11
NCBO	Number of consecutive beams occupied	11

Multi-code reader with text recognition



Learn more

Optical identification of 1D/2D codes and text



- Evaluation of various codes and texts in a single image
- Easy integration and configuration via IO-Link
- Ready to use out of the box, only the codes need to be taught
- Reliable detection even in case of extraneous light and demanding surfaces

Versatile solution for production and logistics

The O2I multicode reader detects 1D and 2D codes as well as text elements. Even in case of multiple codes and text sections or combinations thereof, the O2I provides accurate evaluations in a single image capture. This makes the multicode reader a universally applicable solution for production and logistics processes where codes and text information are to be checked for quality or used for product tracking.

Thanks to the integrated and customisable RGBW lighting, even difficult colour combinations of code / text and background can be read with ease.



Several codes, one image

The auto-find code function of the Vision Assistant automatically recognises several different codes in one image. The user can easily assign these codes in the Vision Assistant.



Identification and verification of text (OCR)

(With new firmware version - from 05/30/2022)

Target / example applications:

- Detection and type designation
- Serial numbers of components
- Expiry date and/or production date
- Product identification



The logic integrated in the ifm VisionAssistant compares the information received from a control system with the code contents read and evaluates them as "OK" or "not OK". The production step is checked by comparing the serial number with a specification.

Based on the contour of the company logo and by tracking the position of the corresponding text, the device always reads the correct text line - irrespective of the orientation of the product.

Use our free firmware update and equip your device with the new functions.

Camera / Vision solutions



Vision sensors for recognition and assessment of objects and scenes.



Type of light	Image Resolution (px)	Inputs / Outputs	A. Standard Lens	B. Wide Angle Lens	C. Telephoto Lens	Price
Ethernet TCP/IP; EtherNet/IP; Operating Distance 5,000mm (max)						
Red light	1,280 x 960	1 / 2	O2I500	-	-	\$3,394.00
Infrared light	1,280 x 960	1 / 2	O2I501	-	-	\$3,394.00
Red light	1,280 x 960	1 / 2	-	O2I502	-	\$3,394.00
Infrared light	1,280 x 960	1 / 2	-	O2I503	-	\$3,394.00



Versatile inspection options

The O2U5 provides the user with almost unlimited combination possibilities in 2D inspection. Surfaces and contours of objects can now be analysed simultaneously with QR or bar codes.

For example, the QR code can be used to check whether the component actually corresponds to the order, while at the same time the contour and surface analysis allows for performing the final quality control before installation.

O2U5: two vision sensors in one

Red light	-	-	O2U530	-	-	\$4,959.00
Infrared light	-	-	-	O2U552	-	\$4,959.00

Note: PROFINET equivalents are available on request.

Application Guideline

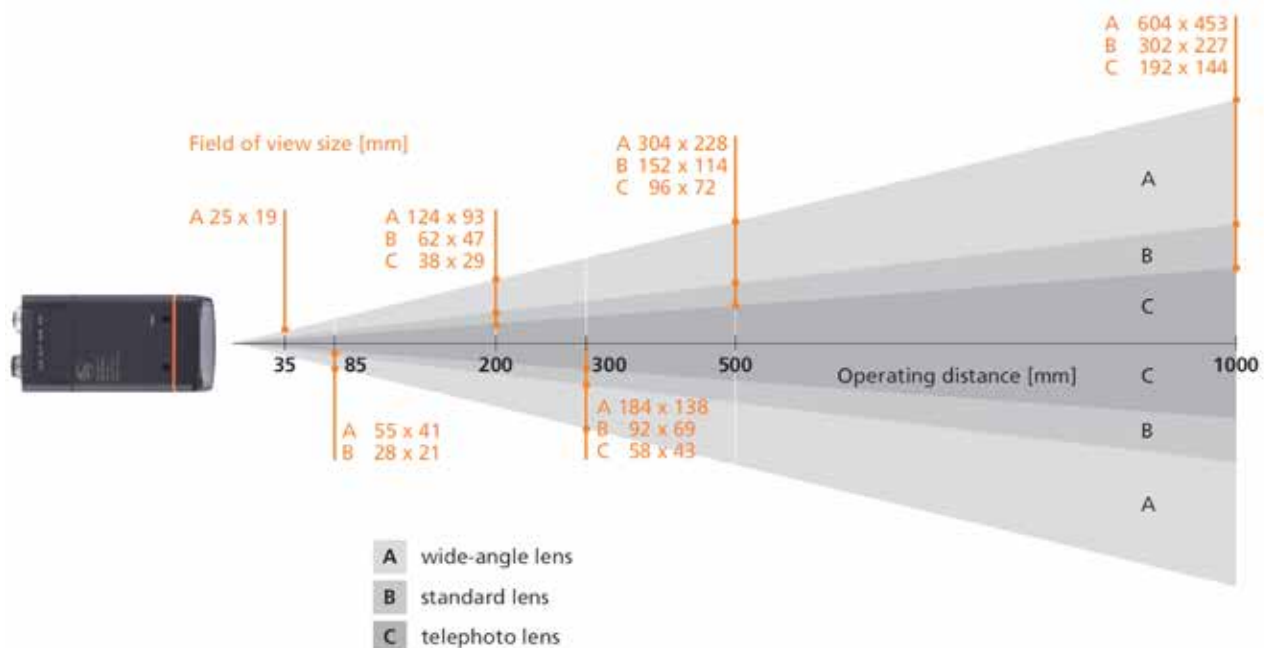

For mounting and connection accessories refer to page 80.

Dualis: Inspect, measure and control objects

2D vision sensors



Learn more



- **2D vision sensor ensures process and object quality**
- **Surface and contour detection for targeted robot arm navigation**
- **User-friendly software simplifies set-up**
- **Reliable functioning in changing light conditions**

Simply solve your application step by step:

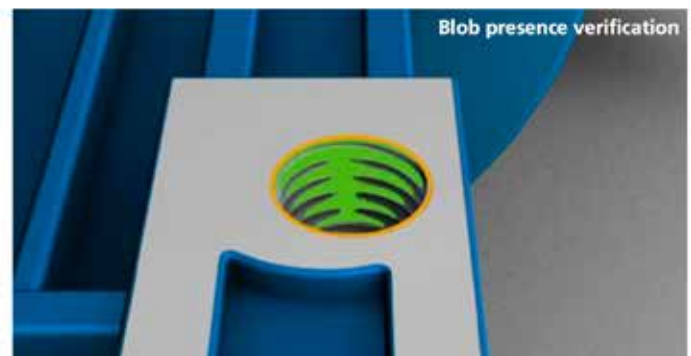
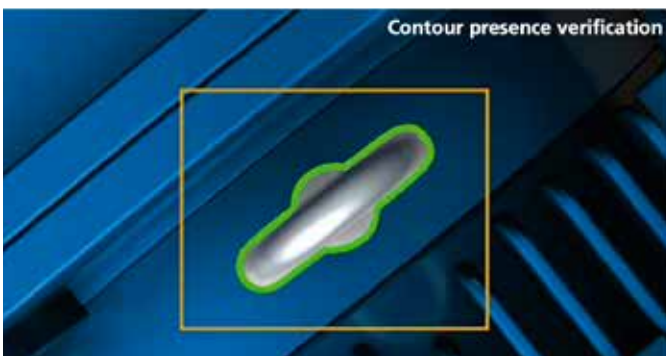

A contour presence verification wizard supports you in solving simple contour presence checks. Even inexperienced users can set up the application within 2 minutes.

Robot sensor calibration

The Robot sensor calibration wizard enables precise control of an object by a robot arm. By means of marker calibration, the coordinate systems of the sensor and the robot are precisely adapted to each other.

Measurement

The wizard for measurement allows determination of contours and surfaces of objects. These can be set in relation to each other and their distance determined as absolute values.

User-defined mode

With the user-defined mode more complex applications with combinations of all functions can be solved.

Simple connection to robots

The ProfiNet version with an L-coded connector for power supply

facilitates direct connection to industrial robots. Using the blob presence verification wizard, you can easily set up an application to analyse blobs. Blobs are contiguous pixels that form an area. These areas can be checked for their size, shape or other properties.

Many options for perfect quality control

The Dualis is available with infrared or RGB-W illumination. The latter makes it possible to distinguish objects by their colour. Highly reflective objects can also be detected easily thanks to the polarisation filter.

In strongly fluctuating light conditions, it takes up to 5 images with different exposure times and then selects the optimally illuminated image for quality control. Thanks to the daylight filter, the Dualis is extremely resistant to extraneous light.

Fast replacement thanks to memory stick The Dualis is equipped with an ifm memory stick on which the parameters and settings are stored. In the event of a device replacement, the stick can be used to easily transfer the data to the new Dualis.

Camera / Vision solutions



Vision sensors for recognition and assessment of objects and scenes



Type of light	Field of view size [mm]	Pixel size [mm]	Standard Lens	Wide Angle Lens	Telephoto Lens	Price
Ethernet TCP/IP; EtherNet/IP, Operating Distance 5,000mm (max)						
RGB-W	1,502 x 1,127	1.17	O2D500	-	-	\$3,293.00
Infrared light	1,502 x 1,127	1.17	O2D520	-	-	\$3,293.00
RGB-W	3,004 x 2,253	2.35	-	O2D502	-	\$3,293.00
Infrared light	3,004 x 2,253	2.35	-	O2D522	-	\$3,293.00

O2U5: two vision sensors in one						
Red light	-	-	O2U530	-	-	\$4,959.00
Infrared light	-	-	-	O2U552	-	\$4,959.00

Note: PROFINET equivalents are available on request.

Application examples

Object and contour detection

- Checks objects based on defined contours
- Ideal solution for applications where shapes are repeated

	Pattern recognition		Object position
	Shape detection		Number of objects
	Orientation		Sorting tasks

Object inspection and blob analysis

- Analyses objects based on their surface area
- Ideal solution for applications where shape and size vary

	Object area		Object contrast
	Object width / height		Orientation
	Inner / outer radius		Object position
	Roundness / rectangularity		Number of objects
	Number of holes		Sorting tasks

For mounting and connection accessories refer to page 76.

Camera/vision solutions

3D vision sensors



Learn more

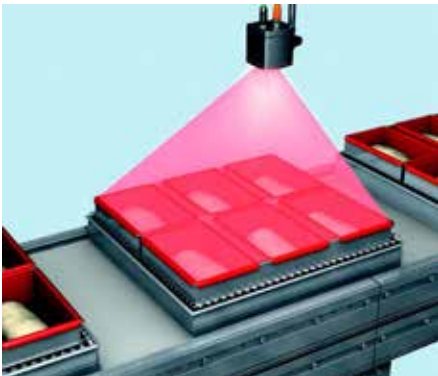

- **Up to 38500 distance values per measurement for a detailed assessment of the application**
- **Different output functions configurable**
- **Visual assessment of distance, level or volume**
- **Predefined function blocks**
- **Reliable function due to time-of-flight measurement**

Photoelectric 3D sensors have a wide range of applications including the detection of volume, distance and level. They measure the distance between the sensor and the nearest surface point by point using the time-of-flight principle. The units illuminate the scene with an internal or external infrared light source and calculate the distance by means of the light reflected from the surface.

The sensors for industrial applications can be used for completeness checks, volume determination or sorting tasks. Sensors for use in mobile machines offer outstanding shock and vibration resistance.

3D Object recognition sensor = missing goods; level detection & volume measurement



Material housing	Material front pane / LED window	Max. field of view size [m]	Order no.	Price
PMD 3D sensors · Type O3D · M12 connector				
Aluminium	Gorilla glass / polyamide	2.61 x 3.47	O3D300	\$3,420.00
Aluminium	Gorilla glass / polyamide	3.75 x 5.00	O3D303	\$3,420.00
SS316L	PMMA (acrylic) / polyamide	2.61 x 3.47	O3D310	\$3,762.00
SS316L	PMMA (acrylic) / polyamide	3.75 x 5.00	O3D312	\$3,762.00

Accessories

Type	Description	Order no.	Price
	Mounting set for clamp mounting, Ø 14 mm, stainless steel	E3D103	\$81.00
	Parameter setting cable, 2 m, M12 D-coded / RJ45, cross-link	E11898	\$112.00
	Socket, M12, 2 m PUR cable, 8-pole	E11950	\$65.00
	Socket, M12, 10 m PUR cable, 8-pole	E11311	\$131.00



Volumetric control

International airport conveyor company Beumer use ifm's 3D sensor to calculate the volume of baggage prior to loading onto a plane. This improves space allocation within storage containers designed for the aircraft.



(De)palletisers

Robots help with palletising and depalletising. The 3D sensor detects the exact position and orientation of the packages. The sensor is set up by the user in a few steps via an app.



Completeness monitoring

The 3D sensor detects overfill or underfill of goods. The time of flight technology used allows evaluation of volume, distance or level and provides the data as switch point or via the Ethernet interface.



Packaging industry: Incomplete shipments, never again!

In the packaging industry, automation must be particularly flexible. A great number of different products, outer packaging and packing units is produced and must reach the customer without any damage or missing parts. Using many individual sensors is often a reliable solution, but replacing a product or a unit often takes a lot of time and can be a source of errors. Using only one sensor that handles many tasks at once makes a lot more sense. The 3D sensor ensures flexible detection of different situations. The integration into the controller is quick and intuitive thanks to the unique configuration software, "Vision Assistant": The configuration only requires 7 steps.















Logistics: Optimise your storage space and transport planning

Constantly increasing freight volumes require efficient solutions for logistics and intralogistics. If each centimetre counts in your storage space and transport planning, the 3D sensor can determine the current volume or the correct position of the freight within milliseconds. This accelerates the warehouse operation and reduces the costs. Autonomous logistics systems are used in transport, handling, packaging and sorting processes and for the shipping of goods. The 3D sensor supports, for example, the precise handling of a forklift truck and thereby reduces possible damage while ensuring a constant material flow.

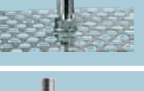
Available on request:



Accessories

Type	Description	Order no.	Price
	External illumination unit	O2D930	\$2,022.00
	Mounting set	E2D501	\$78.00
	External illumination unit	O2D917	\$1,577.00
	Diffuser for illumination units diffuser window ringlight	E2D202	\$440.00
	Mounting set for illumination unit mounting set ringlight / CC	E2D506	\$73.00
	Mounting set	E2D500	\$71.00
	Y splitter, adapter cable for O2I5xx, trigger sensor, 0.4 m PUR cable	EVC847	\$69.00
	Y connection cable for external illumination	EVC848	\$69.00
	Rod, 150 mm, Ø 12 mm, stainless steel	E21111	\$26.00
	Rod, 200 mm, Ø 12 mm, stainless steel	E21112	\$30.00
	Rod, 300 mm, Ø 12 mm, stainless steel	E21113	\$36.00
	Clamp linking ring, high-grade stainless steel	E21076	\$26.00
	2 m, Industrial Ethernet D-code cable (fieldbus) Green, PUR / Ni Pl brass	EVC893	\$34.00
	5 m, Industrial Ethernet D-code cable (fieldbus) Green, PUR / Ni Pl brass	EVC894	\$67.00
	Socket, M12, 2 m PUR cable, 8-pole	E80021	\$56.00
	Socket, M12, 5 m PUR cable, 8-pole	E11807	\$99.00
	Socket, M12, 10 m PUR cable, 8-pole	E11311	\$131.00

Profiler for precise contour detection

Laser sensor



Learn more

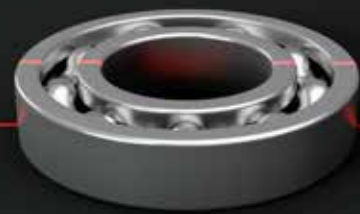

- **Quality control analysis to ensure correct assembly of parts**
- **Intuitive setup; no software required**
- **Two simple modes for optimizing the application**
- **Immunity to extraneous light – no screening or external illumination required**
- **Optional contour visualization via Vision Assistant software to simplify trouble-shooting**

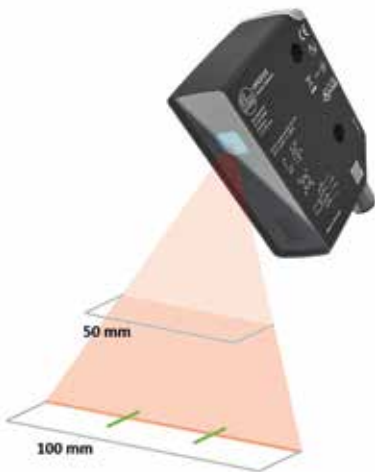

Measuring distance (z direction)	Width of the measuring range (X direction)	Output	Order no.	Price
PMD profiler - M12 connector, Protection Class 1 Laser				
150...300mm	100 (at a maximum distance of 300mm)	PNP/NPN	OPD100	\$1,969.00
150...300mm	100 (at a maximum distance of 300mm) Multiple profiles	PNP/NPN	OPD101	\$2,081.00

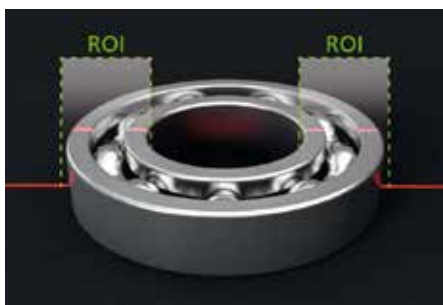

Type	Description	Order no.	Price
	Mounting set OPD, 12 mm	E2D118	\$64.00
	Rod, 100 mm, Ø 12 mm, M10 thread, stainless steel	E20938	\$17.00
	Mounting cube (for aluminium profiles)	E20951	\$25.00

M12 sockets 5-pole (0.34mm sensor)

	2 m black, PUR cable	EVC070	\$38.00
	5 m black, PUR cable	EVC071	\$47.00
	10 m black, PUR cable	EVC072	\$64.00
	15 m black, PUR cable	EVC197	\$72.00
	20 m black, PUR cable	EVC198	\$86.00

Configurable LED signal light towers

Signalling, indication and perfect visibility



Learn more



- Highly visible even in bright lighting conditions
- Loud buzzer (90 dB) with selectable melodies
- High protection rating, also with buzzer. Suitable for wet areas
- Simple installation with M30 fixing nut
- **Control via IO-Link or digital inputs**



Compact signal lamps



Function	Buzzer	Feedback button	IP rating	Order no.	Price
1-segment signal lamp · M12 connectors, Digital inputs / IO-Link					
IO-Link	-	-	IP67	DV2120	\$326.00
IO-Link	-	Yes	IP67	DV2121	\$382.00
IO-Link	max. 90 dB	-	IP65	DV2130	\$381.00
IO-Link	max. 90 dB	Yes	IP65	DV2131	\$437.00
3-segment signal lamp · M12 connectors, Digital inputs / IO-Link					
IO-Link	-	-	IP67	DV1300	\$561.00
IO-Link	max. 90 dB	Yes	IP65	DV1310	\$669.00
IO-Link	-	-	IP67	DV2300	\$535.00
IO-Link	max. 90 dB	Yes	IP65	DV2310	\$619.00



Function	Inputs	Dimensions Ø x h [mm]	IP rating	Order no.	Price
5-segment signal lamp · M12 connectors, Digital inputs / IO-Link					
Mounting base	6	70 x 344	IP 65	DV1500	\$877.00
Mounting base	5	70 x 344	IP 65	DV1501	\$877.00
Mounting base and siren	6	70 x 384	IP 54	DV1510	\$992.00
Mounting base and siren	6	70 x 384	IP 54	DV1511	\$992.00
-	5	70 x 244	IP 65	DV1521	\$776.00
-	6	70 x 284	IP 54	DV1530	\$891.00
Siren	6	70 x 284	IP 54	DV1531	\$891.00
5-segment signal lamp · M12 connectors, IO-Link					
Mounting base	5	70 x 344	IP 65	DV2500	\$849.00
Mounting base and siren	5	70 x 384	IP 54	DV2510	\$963.00
-	5	70 x 244	IP 65	DV2520	\$748.00
Siren	5	70 x 284	IP 54	DV2530	\$863.00

Configurable LED signal light towers



Five segment signal lamp



DV assembly drawing

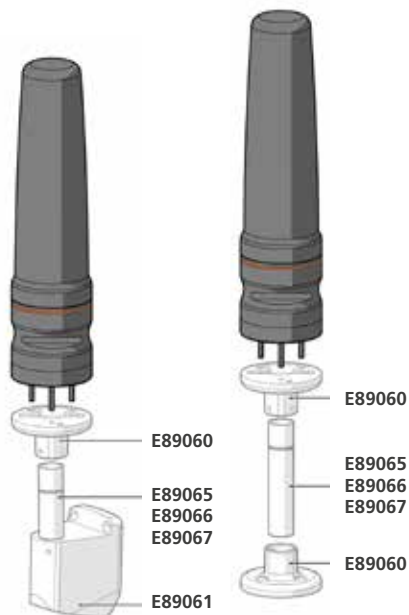

Adapter for side outlet of the cable direct mounting to DV15XX, DV25XX

Type	Description	Order no.	Price
Assembly			
	Mounting adaptor for pole mount	E89080	\$71.00
	Standard bracket for pole mounting	E89060	\$35.00
	Spacer pole 100 mm	E89065	\$29.00
	Spacer pole 300 mm	E89066	\$40.00
	Spacer pole 800 mm	E89067	\$68.00
	Wall bracket for pole mounting	E89061	\$82.00
	Bracket with lateral cable entry	E89064	\$42.00
M12 sockets 4-pole, IP69K, 4A max			
	2 m black, PUR cable, 4 x 0.34 mm ²	EVC001	\$35.00
	5 m black, PUR cable, 4 x 0.34 mm ²	EVC002	\$41.00
	10 m black, PUR cable, 4 x 0.34 mm ²	EVC003	\$50.00
M12 sockets 5-pole, IP69K, 4A max			
	2 m black, PUR cable, 5 x 0.34 mm ²	EVC070	\$38.00
	5 m black, PUR cable, 5 x 0.34 mm ²	EVC071	\$47.00
	10 m black, PUR cable, 5 x 0.34 mm ²	EVC072	\$64.00
M12 sockets 8-pole, IP67, 2A max			
	5 m black, PUR cable, 8 x 0.25 mm ²	E12166	\$73.00
	10 m black, PUR cable, 8 x 0.25 mm ²	E12167	\$104.00
M12 jumper 8-pole, IP67, 2A max			
	5 m black, PUR cable, 8 x 0.25 mm ²	E11230	\$118.00
	10 m black, PUR cable, 8 x 0.25 mm ²	E12360	\$164.00

Flexible LED strip for illumination and signaling



Type	Description	Order no.	Price
	LED-Stripe-RGBW-77mm-IP68	DV1100	\$203.00
	LED-Stripe-RGBW-250mm-IP68	DV1101	\$260.00
	LED-Stripe-RGBW-500mm-IP68	DV1102	\$384.00
	LED-Stripe-RGBW-750mm-IP68	DV1103	\$508.00
	LED-Stripe-RGBW-1000mm-IP68	DV1104	\$633.00

Safety light curtains & light grids

To the highest safety standard



Learn more

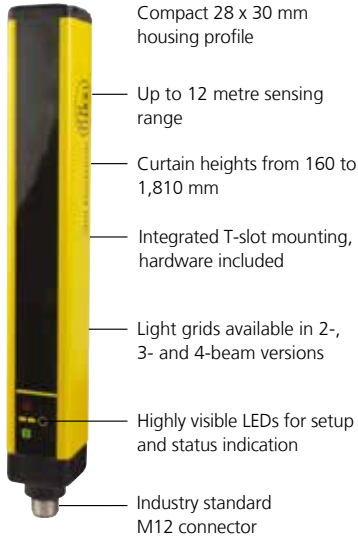

- Compact 28 x 30 mm housing profile
- Up to 12 metre sensing range
- Curtain heights from 160 to 1,810 mm
- Integrated T-slot mounting, hardware included
- Light grids available in 2-, 3- and 4-beam versions
- Highly visible LEDs for setup and status indication
- Industry standard M12 connector

Why choose ifm for your safety products?



- ifm's Type 4 safety light curtains provide an optical solution for protecting plant personnel in unsafe work areas. ifm Type 4 light curtains provide continuous protection, tighter effective aperture range, redundant circuitry and the highest maximum achievable safety level requirements.
- ifm has taken the complexity out of selecting light curtains by offering only Type 4 light curtains.
- ifm offers the optimal resolution models for finger, hand and body protection applications.



Perimeter guarding of palletising area

Corner mirrors allow a single pair of safety light curtains to be used in perimeter guarding applications. Up to three corner mirrors may be used to "bend" the light into shapes that protect multiple sides of the dangerous area.



Palletiser

A palletiser erects a pallet of kegs and places it on a conveyor. Muting sensors are tripped and the pallet is allowed to bypass the light curtain and leave the area. If an operator attempts to enter the palletising area from the opposite direction, the light curtain will detect his presence and cut power to the machine.

Body protection



Type 4 light curtains for body protection

Type	Resolution (mm)	No. of Beams	Protected Area Height (mm)	Protected Area Width (m)	Part No.	Price
Protected area width 0...4 m / 3...12 m - Type 2 / SIL1 / PLc						
	500	2	510	12	OY111S	\$1,999.00
	400	3	810	12	OY112S	\$2,246.00
	300	4	910	12	OY113S	\$2,492.00
Protected area width 0...4 m / 3...12 m - Type 4 / SIL3 / PLe						
	500	2	510	12	OY114S	\$2,546.00
	400	3	810	12	OY115S	\$2,949.00
	300	4	910	12	OY116S	\$3,441.00



Type	Resolution (mm)	Protected Area Height (mm)	Protected Area Width (m)	Part No.	Price
HAND Protected area width 0...4 m / 3...12 m - Type 4 / SIL3 / PLe					
	30	160	12	OY041S	\$2,800.00
	30	310	12	OY042S	\$3,371.00
	30	460	12	OY043S	\$3,853.00
	30	610	12	OY044S	\$4,411.00
	30	760	12	OY045S	\$4,944.00
	30	910	12	OY046S	\$5,480.00
	30	1060	12	OY047S	\$6,029.00
	30	1210	12	OY048S	\$6,565.00
	30	1360	12	OY049S	\$7,086.00
	30	1510	12	OY050S	\$8,087.00
	30	1810	12	OY454S	\$8,694.00
FINGER Protected area width 0...3 m / 1...6 m - Type 4 / SIL3 / PLe					
	14	160	6	OY001S	\$3,390.00
	14	310	6	OY002S	\$4,232.00
	14	460	6	OY003S	\$5,072.00
	14	610	6	OY004S	\$5,926.00
	14	760	6	OY005S	\$6,778.00
	14	910	6	OY006S	\$7,633.00
	14	1060	6	OY007S	\$8,499.00
	14	1210	6	OY008S	\$9,379.00
	14	1360	6	OY009S	\$10,219.00
	14	1510	6	OY010S	\$11,700.00
	14	1810	6	OY011S	\$12,695.00



Carton erecting

Carton machines can jam during the erecting process. Once the operator breaks the protective area of the safety light curtain, the machine stops to allow the operator to clear the jam.

Accessories

Type	Safety Outputs	Non-safe Outputs	Order no.	Price
Safety relays				
	Safety relay, 2 relay outputs, muting function	Relay	G2001S	\$1,299.00
	3 x relay (N.O.) 2 x relay (N.O.) with time delay	1 x relay (N.O.) 1 x relay (N.C.) 1 x PNP with time delay	G1502S	\$839.00



Woodworking Power Saws

Operators are denied access to power saws any time the saws are in motion. Finger protection safety light curtains allow operators to work in close proximity to power saws without risk of injury.

Description	Order No.	Price
Connection Sockets . M12		
Transmitter, 5 m, 5-pole, black, PUR cable	EVC071	\$47.00
Transmitter, 10 m, 5-pole, black, PUR cable	EVC072	\$64.00
Transmitter, 5 m, 5-pole, black, PUR cable	EVC074	\$47.00
Transmitter, 10 m, 5-pole, black, PUR cable	EVC075	\$64.00
Receiver, 2 m, 8-pole, black, PUR cable	E11231	\$82.00
Receiver, 5 m, 8-pole, black, PUR cable	E11232	\$102.00
Receiver, 10 m, 8-pole, black, PUR cable	E12169	\$104.00
Receiver, 2 m, 8-pole, black, PUR cable	E11950	\$65.00
Receiver, 5 m, 8-pole, black, PUR cable	E11807	\$99.00
Receiver, 10 m, 8-pole, black, PUR cable	E11311	\$131.00

Safety sensors

Magnetically-coded sensors



Type	Dimensions [mm]	Range	Connection	Contacts	Order no.	Price
Magnetically coded · actuator is supplied						
	36 x 26 x 13	5 mm	2 m, PVC	2 x NO	MN200S	\$123.00
	36 x 26 x 13	5 mm	M8, 4-pin, integrated	2 x NO	MN202S	\$123.00
	36 x 26 x 13	5 mm	M12, 0.1 m, PVC	2 x NO	MN203S	\$123.00
	36 x 26 x 13	5 mm	6 m, PVC	2 x NO / 1 x NC	MN205S	\$134.00
	88 x 25 x 13	8 mm	2 m, PVC	2 x NO	MN500S	\$125.00
	88 x 25 x 13	8 mm	M8, 4-pin, integrated	2 x NO	MN502S	\$125.00
	88 x 25 x 13	8 mm	M12, 0.1 m, PV	2 x NO	MN503S	\$125.00
	88 x 25 x 13	8 mm	6 m, PVC	2 x NO / 1 x NC	MN505S	\$137.00



- Activation from different directions aids installation
- Conceal behind stainless steel for enhanced tamper prevention
- Connect in series and still identify which door is open
- Meets highest safety level to ISO 13849-1 and SILCL 3 to IEC 62061

Highest protection, coded RFID sensors



Type	Dimensions [mm]	Range	Connection	Coding	Series connection possible	Order no.	Price
RFID-coded · actuator is supplied (right cable entry)							
	72 x 25 x 18	12 mm	M12, 5-pole	coded	-	MN700S	\$268.00
	72 x 25 x 18	12 mm	M12, 8-pole	uniquely coded	•	MN701S	\$281.00
	72 x 25 x 18	12 mm	M12, 8-pole	codable	•	MN702S	\$281.00



- Unique actuator coding prevents tampering
- Connect up to 32 sensors in series with the safety integrity remaining at the same level
- Flashing LEDs monitor sensing area
- Program the sensor as often as desired, ensuring easy set-up



Safety sensors

Fail-safe inductive sensors



Series connection (up to 10 sensors)

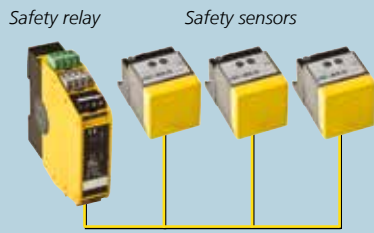

Type	Size mm	Enable zone	Order no.	Price
Safety sensors				
	M12, L = 60	0...1.5 - 6 mm, nf	GF762S	\$597.20
	M12, L = 70	0.5...4 mm, nf	GF711S	\$242.00
	M18, L = 60	0...3.5 mm - 10.5mm, nf	GG762S	\$642.40
	M18, L = 90	3...6 mm, nf	GG505S	\$339.00
	M18, L = 60	1 7.5 mm, nf	GG855S	\$250.00
	M18, L = 70	1...8 mm, nf	GG711S	\$272.00
	M18, L = 60	1...8 mm, nf	GG712S	\$281.00
	M18, L = 60	1 11.5 mm, nf	GG854S	\$250.00
	M30, L = 65	0...6 mm - 18mm, nf	GI762S	\$669.60
	M30, L = 70	1...10 mm, nf	GI712S	\$281.00
	M30, L = 65	1 14.5 mm, nf	GI855S	\$258.00
	M30, L = 65	1 21.5 mm, nf	GI854S	\$252.00
	40 x 40 x 66 mm	10...20 mm, nf	GM505S	\$357.00
	40 x 40 x 66 mm	4...20 mm, nf	GM705S	\$632.00

Safety Relays



ifm's multi-functional safety relay is compatible with industry standard devices



Type	Inputs	Safety Outputs	Order no.	Price
Safety relays				
	S34 S43	2 safety-related NO contacts (floating contacts); 1 signal output (positive switching)	G1501S	\$484.00
	"1" >11 V 6 mA	3 safety-related NO contacts (floating) without delay; 2 non safety-related signal outputs without delay (1 x NO, 1 x NC, floating contacts) 2 safety-related NO contacts (floating) with switch-off delay 1 signal output (positive switching) with delay	G1502S	\$839.00
	"0" < 5 V < 500 µA	2 safe short-circuit proof semiconductor outputs (positive switching), 1 signal output (positive switching)	G1503S	\$400.00
AS-i Safety relay				
		<ul style="list-style-type: none"> For the safe monitoring of protective systems Areas of application: door monitoring, light grids, E-STOP, two-hand control Monitoring of up to 31 safe AS-i slaves Replacement for a large variety of standard safety relays Can be integrated into the AS-i network at any position 	AC041S	\$1,575.00

Ultra-sonic sensors

Ranges vary from 40mm...8m
Ideal for transparent or bulky targets



Learn more



Object / Application	Ultrasonic sensor	Laser sensor	Photoelectric sensor
Long range (>1m)	✓	✓	✓
Different colour targets	✓	✓	⚠
Shiny objects	✓	✓	⚠
Transparent film	✓	✗	✓
Irregular objects	✓	⚠	⚠
Level irregular objects (seeds, potatoes)	✓	⚠	⚠
Objects with holes	✓	✗	⚠
Transparent objects	✓	✗	⚠
Large area One signal	✓	✗	⚠
Transparent liquids	✓	✗	✗
Dynamic application	⚠	⚠	✓
Angle to target	✗	✓	⚠
Small targets	✗	✓	⚠

Design	Range [mm]	Output	Setting	Order no.	Price
Diffuse sensor · 3-wire DC, 4-pole, stainless steel					
M18 x 60mm	40...300	PNP, NO/NC Prog	Wire	UGT500	\$439.00
M18 x 60mm	40...300	PNP, NO/NC Prog	IO-Link	UGT524	\$443.00
Diffuse sensor · 4-wire DC, 4-pole, stainless steel					
M18 Cube	40...300	PNP + 4...20 mA	Button	UGT580	\$487.00
M18 Cube	40...300	PNP, NO/NC Prog	Button / IO-Link	UGT592	\$491.00
M18 Cube	60...800	PNP + 4...20 mA	Button	UGT582	\$487.00
M18 Cube	80...1,200	PNP + 4...20 mA	Button	UGT584	\$487.00
M18 Cube	80...1,200	PNP, NO/NC Prog	Button / IO-Link	UGT594	\$491.00
Diffuse sensor · 4-wire DC, 4-pole, IO-Link, PBT plastic					
M18 x 98mm	150...1,600	2 x PNP, NO/NC Prog	Button, IO-Link	UGT203	\$532.00
M18 x 98mm	150...1,600	PNP + 4...20 mA	Button, IO-Link	UGT204	\$532.00
Diffuse sensor · 4-wire DC, 4-pole, stainless steel					
M18 x 98mm	200...2,200	2 x PNP, NO/NC Prog	Button, IO-Link	UGT510	\$593.00
M18 x 98mm	200...2,200	PNP + 4...20 mA	Button, IO-Link	UGT511	\$593.00
M18 x 98mm	200...2,200	2 x PNP, NO/NC Prog	Button, IO-Link	UGT512	\$593.00
M18 x 98mm	200...2,200	PNP + 4...20 mA	Button, IO-Link	UGT513	\$593.00
M18 x 98mm	200...2,200	PNP + 0...10 V	Button, IO-Link	UGT514	\$593.00

Accessories

Type	Description	Order no.	Price
	Mounting set, Ø 18.5 mm clamp mounting, high-grade stainless steel (M10 cap screw)	E20870	\$43.00
	Mounting set, Ø 30.2 mm clamp mounting, high-grade stainless steel	E20874	\$43.00
	Mounting rod, 100 mm, Ø 12 mm, M10, stainless steel	E20938	\$17.00
	Angle bracket for type M30, stainless steel	E10737	\$10.00
	Sound tube, M18, POM	E23000	\$64.00
	Sound tube, M30, POM	E23007	\$71.00
	Sound deflection angle for sensors with a range of ≤ 1,2 m, stainless steel	E23001	\$57.00
	Sound deflection angle for sensors with a range of ≤ 2,2 m, stainless steel	E23002	\$63.00

Process values from sensors at a glance



Learn more

Multifunction display for analogue signals



- **Universal measurement input for various types of signals (current, voltage, frequency, pulses, PT100/PT1000 and thermocouples)**
- **Colour TFT display with extensive digital labelling**
- **Intuitive menu structure with help texts for easy parameter setting**
- **8 adjustable alarms and 2 relay outputs**
- **Low installation depth with standard panel cut-out**

Clear representation

The TFT display offers various possibilities and colours to visualise the measured value. The unit of measurement also displayed, the signal name and the location tag clearly explain the meaning of the displayed value.

The different font and background colours of the definable alarms help to evaluate the measured value. Via the two relay outputs, individual alarms can be transferred to higher-level systems, or simple controls can be realised.

Multi-functional TFT Display for impulse signals, analogue signals & Temperature

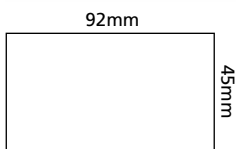

Panel cut-out

Power supply	Inputs	Outputs	Order no.	Price
IP65 multi-function TFT display				
24 VDC	V, mA, kHz, °C, PT100, PT1000, thermocouple	2 x relays	DX1063	\$564.00





Nominal voltage [V]	Inputs	Outputs	Order no.	Price
Multifunction display with IO-Link · touch display and clear text				
115 / 230 AC; 24 DC	2 x analogue	4	DX2045	\$963.00
24 DC	2 x analogue	4	DX2055	\$902.00
Multifunctional analogue display				
115 / 230 AC 18...30 DC	2 x analogue	4	DX2042	\$812.00
115 / 230 AC 18...30 DC	2 x analogue	4 + 4...20 mA	DX2043	\$889.00
Multifunctional display: speed, time, counter				
115 / 230 AC 24 DC	2 x pulse	4 x transistor, 1x analogue	DX2022	\$736.00

Filter monitoring system for industrial plants

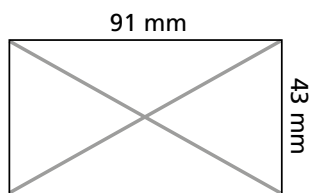

Panel cut-out



Transmitter - system layout

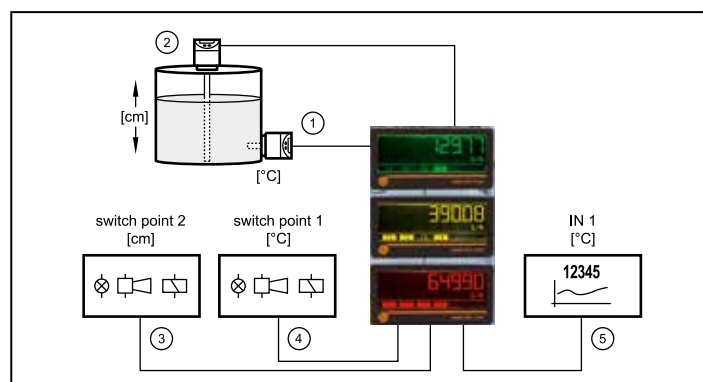

Principle 2CH mode
Limit value monitoring of 2 independent, different process values (here e.g. temperature [°C] and level [cm])

- 1: Temperature sensor [°C]
- 2: Level sensor [cm]
- 3: Switching output 2, here limit value 2 for level [cm]
- 4: Switching output 1, here limit value 1 for temperature [°C]
- 5: Analogue output for display, evaluation or recording of IN1, here [°C]

Control displays: Processing of Input/Output values



Evaluation for analogue signals



- Monitoring, analysis and offsetting of two analogue values
- Ideal for determining differential values, e.g. pressure, flow, level or temperature values
- Limit value indication via two separate relay outputs
- Extensive and convenient parameter setting via IO-Link
- Clearly visible OLED display for actual value indication and parameter setting

Nominal voltage [V]	Inputs	Outputs	Order no.	Price
2-channel analogue threshold relay for analogue standard signals				
110...240 AC, 24 DC	4...20 mA or 0...10 V	IO-Link, 2 x relay, 1 x analogue	DL3003	\$705.00

Power supply with switching capability



Nominal voltage [V]	Inputs	Outputs	Order no.	Price
Power supply and signal evaluation				
110...240 AC, 24 DC	2x PNP/NPN	2x relay	DN0220	\$394.00

IO-Link Master Display



Type	Length	Order no.	Price
128 x 128 resolution, 1.44" TFT LED display			
	IO-Link display · Connection to master · Assignment of the values displayed by the controller ·	E30391	\$303.00
	IO-Link inline display · Connection between master and sensor Visualisation of the values of the connected sensor	E30430	\$357.00
	IO-Link display · Shows all sensor process values connected to a master	E30443	\$475.00

Accessories

Type	Length	Order no.	Price
		E30429	\$21.00

Loop powered display for 4...20mA signals



Power Supply	Input / output	Display range	Order no.	Price
Loop powered display for 4...20mA signals				
Analogue signal	4...20 mA loop powered	-1,999...1,999	DX1041	\$376.00

Pressure sensors and mounting accessories



Learn more

PN Series

2-color digital display is easier to see from a distance

Robust 316 stainless steel construction

Laser etched part numbers will not fade for future referencing

Sensor can be rotated 345° for optimum visibility after installation

Large bright LEDs can be seen from all angles indicate output status

Simple pushbutton setup allows the sensor to be parameterised in less than 5 minutes with new scroll and enter buttons

QR code for quick access to technical data and installation instructions

Atmospheric reference is achieved via the electrical connection for high IP67 rating

Process connection, G1/4" = 1/4" PSP-P
Ceramic diaphragm withstands pressure spikes

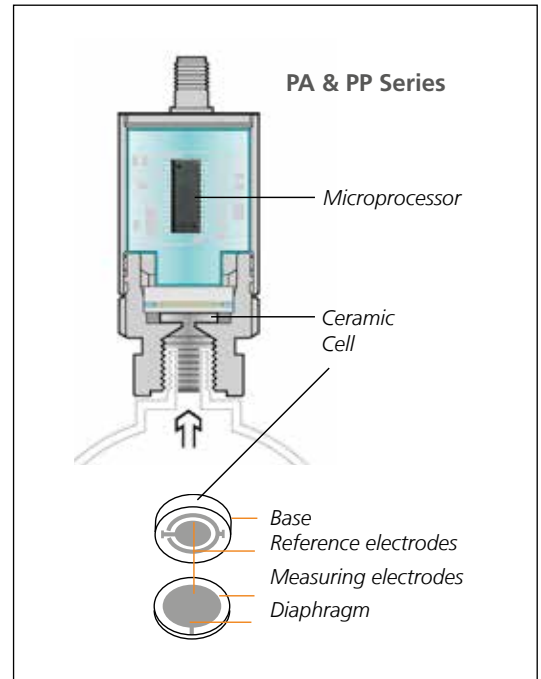

NEW PRODUCT

Highly visible electronic manometer with bright LED visualisation

Rotatable display 350° for mounting flexibility

LED ring visualisation of acceptable and unacceptable ranges

Clear pressure indicator

Application parameters are setup via optical touch-screen pushbuttons

High protection rating (IP67 / IP69K)

Stable measured value if pressure fluctuates

Customisable LED display colours over the analogue scale

Extended display range

All electronic, does not require damping liquid



The new (see in the dark) LED Manometer pressure sensor, makes instrument monitoring easier in dark industrial settings.

* German factory calibration must be ordered separately when placing a pressure sensor PO
This service will result in 4 - 6 weeks delivery delay
For local calibration by a certified laboratory, we can provide partner information on request

Ceramic pressure sensor technology



Why ceramic capacitive cells are best for most applications

After >50 years of R&D in pressure sensor technology, ifm electronic now offer the most advanced electronic sensor technology available.

ifm pressure sensors operate in virtually every application. With the majority working in non-Ex rated Industrial plants - monitoring Hydraulics, Pneumatic, Water and Hygienic F&B applications. While withstanding harsh and often rapid fluctuations in process temperature & pressure.

ifm leads the development of pressure sensors utilizing Ceramic Capacitive diaphragms. With advanced electronic circuitry, ifm now produce and offer extremely high accuracy pressure sensors, matching traditional liquid filled types, while overcoming most application issues experienced in daily use of thin metal diaphragm types. These issues include hydraulic pressure spikes, metal corrosion, vacuum effects & surface abrasion.

Following is a summary of the pros & cons of each technology, to assist optimum selection for your application:

Introducing ifm's latest range of state of the art pressure transmitters



IO-Link communication protocol improves reading accuracy & diagnostic information



Pressure sensors/viscous media

Electronic manometer with LED visualisation



Ceramic PG Series - G1 (BSP) Aseptoflex Vario, Flush Pressure & Temperature Sensor with LED visualisation



Type	Factory setting measuring range relative pressure [bar]	Measuring range relative pressure [bar]	Temp range [°C]	Order no.	Price
Hygienic - G1 (BSP) Aseptoflex Vario, Prog, PNP/NPN NO/NC + 4...20 mA, -25...+125° C					
	0...40	-1...40	-25...150	PG1743	\$1,459.00
	0...25	-1...25	-25...150	PG1703	\$1,459.00
	0...16	-1...16	-25...150	PG1714	\$1,459.00
	0...10	-1...10	-25...150	PG1704	\$1,459.00
	0...6	-1...6	-25...150	PG1715	\$1,459.00
	0...4	-1...4	-25...150	PG1705	\$1,459.00
	2.5	-0.124...2.5	-25...150	PG1706	\$1,459.00
	1.6	-0.1...1.6	-25...150	PG1717	\$1,459.00
	-1...1	-1...1	-25...150	PG1709	\$1,499.00
	1	-0.05...1	-25...150	PG1707	\$1,499.00
	0.25	-12.4...250 mBar	-25...150	PG1708	\$1,499.00

Ceramic PG series - G1 Connection - Motor driven Manometer

This product is being phased out, we recommend using the NEW LED product shown above.



Type	Factory setting measuring range relative pressure [bar]	Measuring range relative pressure [bar]	$p_{\text{overload max.}}$ [bar]	Order no.	Price
Programmable PNP/NPN NO/NC + 4...20 mA/20...4mA, -25...+125° C					
	0...25	-1...25	100	PG2793	\$1,576.00
	0...10	-1...10	50	PG2794	\$1,576.00
	0...4	-1...4	30	PG2795	\$1,576.00
	0...25	-0.124...2.5	20	PG2796	\$1,576.00
	-1...1	-1...1	10	PG2799	\$1,619.00
	0...1	-0.05...1	10	PG2797	\$1,619.00
	0...250 mB	-12.4...250 mB	10	PG2798	\$1,619.00
	0...100 mB	-5...100 mB	4	PG2789	\$1,619.00

Pressure sensors/viscous media

Ceramic PI series - G1 Connection



Type	Factory setting measuring range [bar]	Measuring range [bar]	Order no. (high res)	Price	Order no.	Price
1 switching output and 1 analogue output 4...20 mA / 20...4 mA G 1 male Aseptoflex Vario						
	0...25	-1...25	PI1703	\$1,431.00	PI2793	\$1,560.00
	0...16	-1...16	PI1714	\$1,367.00	PI2714	\$1,560.00
	0...10	-1...10	PI1704	\$1,367.00	PI2794	\$1,560.00
	0...6	-1...6	PI1715	\$1,367.00	PI2715	\$1,560.00
	0...4	-1...4	PI1705	\$1,367.00	PI2795	\$1,560.00
	0...2.5	-0.124...2.5	PI1706	\$1,367.00	PI2796	\$1,560.00
	0...1.6	-0.1...1.6	PI1717	\$1,367.00	PI2717	\$1,560.00
	-1...1	-1...1	PI1709	\$1,408.00	PI2799	\$1,605.00
	-0.05...1	-0.05...1	PI1707	\$1,408.00	PI2797	\$1,605.00
	0...400 mB	-50...400 mB	PI1718	\$1,408.00	-	-
	0...250 mB	-12...250 mB	PI1708	\$1,408.00	PI2798	\$1,605.00
	0...100 mB	-5...100 mB	PI1789	\$1,408.00	PI2789	\$1,605.00

Ceramic PM series - G1 connection



Hygienic Cleanable EC 1935/2004

For process adapters and accessories see pages 94



Type	Factory setting measuring range relative pressure [bar]	Measuring range relative pressure [bar]	P _{overload} max. [bar]	Order no.	Price
Aseptoflex Vario, 4...20 mA, IO-Link					
	0...25	-1...25	100	PM1703	\$1,140.00
	0...16	-1...16	75	PM1714	\$1,140.00
	0...10	-1...10	50	PM1704	\$1,140.00
	0...6	-1...6	30	PM1715	\$1,140.00
	0...4	-1...4	30	PM1705	\$1,140.00
	0...2.5	-0.125...2.5	20	PM1706	\$1,140.00
	0...1.6	-0.1...1.6	15	PM1717	\$1,140.00
	-1...1	-1...1	10	PM1709	\$1,174.00
	0...1	-0.05...1	10	PM1707	\$1,174.00
	0...400 mB	0...400 mB	6	PM1718	\$1,174.00
	0...250 mB	12.5...250 mB	6	PM1708	\$1,174.00
	0...100 mB	5...100 mB	4	PM1789	\$1,174.00

Ceramic PM series - G1/2 connection - comes with integrated temperature measurement via io-Link



Type	Factory setting measuring range relative pressure [bar]	Measuring range relative pressure [bar]	P _{overload} max. [bar]	Order no.	Price
G 1/2 male sealing cone, 4...20 mA, IO-LINK					
	0...40	-1...40	200	PM1543	\$1,103.00
	0...25	-1...25	160	PM1503	\$1,103.00
	0...16	-1...16	110	PM1514	\$1,103.00
	0...10	-1...10	75	PM1504	\$1,103.00
	0...6	-1...6	50	PM1515	\$1,103.00
	0...4	-1...4	40	PM1505	\$1,103.00
	0...1	-0.5...1	40	PM1507	\$1,108.00
	0...2.5	-0.125...2.5	30	PM1506	\$1,103.00

Pressure Sensors

PG series - G1/2 (BSP) Connection, medium temp -25...80, with LED visualisation, IP69k



The new (see in the dark) LED Manometer pressure sensor, makes instrument monitoring easier in dark industrial settings.

- Optimum interpretation of measured values, e.g. through operating ranges that can be customised in colour as well as threshold and trend displays
- Pressure peak and overload-resistant ceramic measuring cell with diagnostic function
- Fast compensation of dynamic temperature changes
- Permanent 150°C medium temperature
- Very high resolution thanks to 32-bit process value transmission via IO-Link

PG Series - Industrial G1/2 (BSP), Pressure & Temperature Sensor with LED visualisation



Type	Factory setting of the measuring range [bar]	Measuring range of the relative pressure [bar]	P _{overload max.} [bar]	Order no.	Price
Industrial - G1/2 (BSP), Programmable PNP/NPN NO/NC + 4...20 mA, -25...+125° C					
	400	0...400	800	PG1400	\$1,124.00
	250	0...250	600	PG1401	\$1,085.00
	160	0...160	300	PG1412	\$1,085.00
	100	0...100	300	PG1402	\$1,085.00
	60	0...60	100	PG1423	\$1,085.00
	0...25	-1...25	100	PG1403	\$1,085.00
	16	-1...16	50	PG1414	\$1,085.00
	0...10	-1...10	50	PG1404	\$1,085.00
	6	-1...6	30	PG1415	\$1,085.00
	0...4	-1...4	30	PG1405	\$1,085.00
	2.5	-0,124...2,5	20	PG1406	\$1,085.00
	-1...1	-1...1	10	PG1409	\$1,124.00
	1	-0.05...1	10	PG1407	\$1,124.00
0.25	-12.4...250 mB	10	PG1408	POA	

PG series - G1/2 (BSP) Connection - Motor driven Manometer

This product is being phased out, we recommend using the NEW LED product shown above.

Type	Factory setting measuring range relative pressure [bar]	Measuring range relative pressure [bar]	P _{overload max.} [bar]	Order no.	Price
Programmable PNP/NPN NO/NC + 4...20 mA/20...4mA					
	0...400	0...400	800	PG2450	\$1,215.00
	0...250	0...250	600	PG2451	\$1,181.00
	0...100	0...100	300	PG2452	\$1,181.00
	0...25	-1...25	100	PG2453	\$1,181.00
	0...10	-1...10	50	PG2454	\$1,181.00
	0...4	-1...4	30	PG2455	\$1,181.00
	0...2.5	-0.125...2.5	20	PG2456	\$1,181.00
	0...1	-0.05...1	10	PG2457	\$1,215.00
	0...250 mB	-12.5...250 mB	6	PG2458	\$1,215.00
	0...100 mB	-5...100 mB	4	PG2489	\$1,215.00

Pressure Sensors



Ceramic PL series - G1/2 flush connection

Pressure sensors type PL

Programmable IO-Link pressure sensor with switching outputs.

Robust ceramic flush measuring cell.



Note: EPDM for ammonia refrigerant applications.



Type	Measuring range factory setting [bar]	Measuring range relative pressure [bar]	Article no.	Price
Pressure / Temperature Sensor – 2x IO-Link Outputs, G 1/2" Male				
	0...160	0...160	PL1512	\$689.00
	0...100	0...100	PL1502	\$689.00
	0...60	0...60	PL1523	\$689.00
	0...40	-1...40	PL1543	\$689.00
	0...25	-1...25	PL1503	\$689.00
	0...16	-1...16	PL1514	\$689.00
	0...10	-1...10	PL1504	\$689.00
	0...10	-1...10 (EPDM seal)	PL1604	\$691.00
	0...6	-1...6	PL1515	\$689.00
	0...2.5	-0.125...2.5	PL1506	\$689.00
	0...1	-0.05...1	PL1507	\$718.00

PI series - for high temperature applications

For process adapters and accessories see pages 94



Type	Factory setting measuring range relative pressure [bar]	Measuring range relative pressure [bar]	P _{overload max.} [bar]	Order no.	Price
1 switching output and 1 analogue output 4...20 mA / 20...4 mA Clamp 1.5" (200°)					
	0...25	-1...25	80	PI2203	\$1,908.00
	0...10	-1...10	50	PI2204	\$1,908.00
	0...4	-1...4	30	PI2205	\$1,908.00
	0...2.5	-0.0124...0.25	20	PI2206	\$1,908.00
	-1...1	-1...1	10	PI2209	\$1,963.00
	0...1	-0.05...1	10	PI2207	\$1,963.00

Ceramic PY Series - Precise monitoring of homogeniser processes



Type	Process Connection	Measuring range [bar]	P _{overload max.} [bar]	P _{bursting min.} [bar]	Order no.	Price
M12 connector - Output function 2 x NO / NC prog or 1 x normally NO / NC prog + 1 x analogue (4...20 mA / 0...10 V; scaleable 1:4)						
	-	0...400	600	1000	PY9070	\$3,114.00
	Clamp fitting	0...600	800	1200	PY9060	\$2,191.00

Pressure sensor mounting accessories



Process adapters



Device connection	Process connection	Sealing	For sensor type	Order no.	Price
High-grade stainless steel adapter (316L/1.4435) for hygienic applications					
G 1 male Aseptoflex Vario	Clamp 1 - 1.5	sealing ring	PG27xx, PI27xx	E33201	\$125.00
		sealing ring		E33208	\$135.00
		metal-to-metal		E33701	\$111.00
	Clamp 2"	sealing ring		E33202	\$147.00
		sealing ring		E33209	\$155.00
		metal-to-metal		E33702	\$132.00
	pipe fitting DN40 (1.5")	sealing ring		E33212	\$125.00
		metal-to-metal		E33712	\$117.00
	pipe fitting DN50 (2")	sealing ring		E33213	\$147.00
G 1/2	metal-to-metal	E33713	\$132.00		
		sealing ring	E30131	\$149.00	

Adapter accessories



Device connection	Process connection	Sealing	For sensor type	Order no.	Price
High-grade stainless steel welding adapters for hygienic applications					
G 1 male Aseptoflex Vario	welding adapter D50	sealing ring	PG27xx, PI27xx	E30122	\$101.00
				E30130	\$129.00
G 1 male Aseptoflex Vario	welding mandrel	-		E30435	\$95.00

Process adapters



Adapter accessories for hygienic applications						
G 1 male Aseptoflex Vario		sealing plug	PG27xx, PI27xx		E30128	\$111.00
		FKM O-ring			E30123	\$11.00
		PEEK ring			E30124	\$41.00

Hygienic screw-in adapter for process sensors					
G 1/2 clamp	sealing plug	metal-to-metal	PL15	E43917	\$118.00

Industrial Pressure sensor mounting accessories

Process adapters



Device connection	Process connection	Material	Order no.	Price
Adapters for industrial applications -For sensor type PN, PA with internal thread				
G 1/4	G 1/4	high-grade stainless steel (316L/1.4404) FKM	E30143	\$43.00
G 1/4	G 1/2	stainless steel (303/1.4305), FPM (Viton)	E30050	\$47.00
G 1/4	G 1/2	high-gr. stainl. steel (316L/1.4404) FPM (Viton)	E30002	\$61.00
G 1/4	M20 x 1.5	stainless steel (303/1.4305), FPM (Viton)	E30010	\$45.00
G 1/4	1/4" NPT	high-grade stainless steel (316Ti/1.4571)	E30058	\$55.00
G 1/4	1/2" NPT	high-grade stainless steel (316L/1.4404)	E30133	\$64.00

Accessories



Description	For sensor type	Order no.	Price
Accessories for industrial applications			
Damping screw for PN with G 1/4 internal thread		E30419	\$24.00
Protective cover	PN	E30420	\$11.00
Angle bracket		E30421	\$15.00
Damping screw for sensors with G 1/4 external thread		E30057	\$15.00
Syphon G 1/4	PN, PK, PA35xx	E30140	\$60.00
Syphon G 1/2	PG24	E30141	\$96.00
Protective cover	PK	E30094	\$12.00
Cable clamp fastener		E30399	\$58.00
Filter element		E30400	\$16.00
Splitter box with ventilation and terminal block	PS	E30401	\$215.00
Adapter R 1/8 - R 1/8 rotatable	PQ	E37350	\$49.00

Pressure sensors type PN

Universal application areas: High overload, IP 67 in pressure ranges of -1...600 bar.



- **Red / Green LEDs:** "Good ranges" or switching states can be identified quickly via the display colour
- **Quick setting:** Easy to use via 3 pushbuttons
- **Orientation:** Process connection rotatable by approx. 345°
- **M12 connector**

Measuring Cell	Process connection	Pressure range [bar]	P _{overload} max. [bar]	Order no. G 1/4 female	Price
Pressure transmitter - output function programmable, 1 x NO/NC + 4...20 mA/0...10V					
Stainless steel chamber	G 1/4" female	0...600	800	PN2160	\$1,001.00
Stainless steel chamber	G 1/4" female	0...400	800	PN2070	\$1,001.00
Stainless steel chamber	G 1/4" female	0...250	500	PN2071	\$972.00
Ceramic capacitive	G 1/4" female	0...100	300	PN2092	\$972.00
Ceramic capacitive	G 1/4" female	0...25	150	PN2093	\$972.00
Ceramic capacitive	G 1/4" female	-1...10	75	PN2094	\$972.00
Ceramic capacitive	G 1/4" female	-0.125...2,5	20	PN2096	\$972.00
Ceramic capacitive	G 1/4" female	-0.05...1	10	PN2097	\$1,001.00
Ceramic capacitive	G 1/4" female	-1...1	10	PN2099	\$1,001.00
Ceramic capacitive	G 1/4" female	-0.5...0.5	10	PN2169	\$1,001.00

Pressure transmitter - designed for refrigeration applications (EPDM seals)					
Ceramic capacitive	G 1/4" female	0...100	300	PE2092	\$969.00
Ceramic capacitive	G 1/4" female	-1...25	150	PE2093	\$969.00
Ceramic capacitive	G 1/4" female	-1...10	75	PE2094	\$969.00

Pressure switch - output function programmable, 2 x NO/NC					
Stainless steel chamber	G 1/4" female	0...600	800	PN7160	\$816.00
Stainless steel chamber	G 1/4" female	0...400	800	PN7070	\$816.00
Stainless steel chamber	G 1/4" female	0...250	500	PN7071	\$792.00
Ceramic capacitive	G 1/4" female	0...100	300	PN7092	\$792.00
Ceramic capacitive	G 1/4" female	0...25	150	PN7093	\$792.00
Ceramic capacitive	G 1/4" female	-1...10	75	PN7094	\$792.00
Ceramic capacitive	G 1/4" female	0...2,5	20	PN7096	\$792.00
Ceramic capacitive	G 1/4" female	0...1	10	PN7097	\$816.00
Ceramic capacitive	G 1/4" female	-1...1	20	PN7099	\$816.00

IMPORTANT!

Play it safe, always use a damping screw to protect your PN / PA series pressure sensors against systematic pressure spikes, that can potentially destroy the instrument.

Pressure spikes from auto opening / closing valves are a common hazard for pressure instruments.

Type	Description	Order no.	Price
	Damping screw , for surge pressure protection. For PN / PA sensors with G1/4 fittings	E30419	\$24.00

Pressure sensors type PA, PT, PV & PL



Ceramic PA series

Pressure transmitters type PA

Pressure transmitters with fixed measuring range.

High resistance to overload due to ceramic measuring cell.

Note: PA3589 is male connection

Type	Measuring range Relative pressure [bar]	P _{overload max.} [bar] static	Order no.	Price
Pressure transmitter, fixed range, G1/4 (female) , Output function 4...20 mA				
	0...10	75	PA3024	\$586.00
	0...2.5	20	PA3026	\$586.00
	-1...0	10	PA3029	\$603.00
	0...1	10	PA3027	\$603.00
	0...0.25	6	PA3028	\$659.00
	0...0.1	4	PA3589*	\$665.00

Compact fixed range pressure transmitters without display



Pressure transmitters type PT

Pressure transmitters with fixed measuring range.

Fast response time of 1 ms.

Stainless steel measuring cell without any seal.

Type	Measuring range Relative pressure [bar]	P _{overload max.} [bar]	Order no.	Price
Gauge pressure transmitter, G1/4 Connection Output function 4...20 mA, Loop power				
	0...600	1,500	PT5460	\$282.00
	0...400	1,000	PT5400	\$282.00
	0...250	625	PT5401	\$274.00
	0...160	400	PT5412	\$274.00
	0...100	250	PT5402	\$274.00
	0...40	100	PT5443	\$274.00
	0...25	65	PT5403	\$274.00
	0...16	40	PT5414	\$274.00
	0...10	25	PT5404	\$274.00
	0...6	15	PT5415	\$274.00
	-1...10	25	PT5494	\$274.00

PV series - pressure sensor with integrated temperature measurement

Pressure sensors type PV

Programmable IO-Link pressure sensor with switching outputs. Stainless steel measuring cell without any seal IO-Link.



Type	Measuring range [bar]	P _{overload max.} (static) [bar]	P _{bursting min.} [bar]	Order no.	Price
Pressure / Temperature Sensor – 2x IO-Link Outputs, G 1/4" Male					
	0...600	1,500	2,500	PV8060	\$371.00
	0...400	1,000	1,700	PV8000	\$371.00
	0...250	625	1,200	PV8001	\$362.00
	0...100	250	1,000	PV8002	\$362.00
	0...60	150	900	PV8023	\$362.00
	-1...25	65	600	PV8003	\$362.00
	-1...10	25	300	PV8004	\$362.00

PL series - G1/4 flush connection



Type	Measuring range [bar]	P _{overload max.} (static) [bar]	P _{bursting min.} [bar]	Order no.	Price
Pressure / Temperature Sensor – 2x IO-Link Outputs, G 1/4" Male					
	0...400	1,000	1,700	PL5400	\$626.00
	0...250	625	1,200	PL5401	\$626.00
	0...160	400	1,100	PL5412	\$626.00
	0...100	250	1,000	PL5402	\$626.00
	0...60	150	900	PL5423	\$626.00

Pressure sensors type PK, PQ & PT



PK series - pressure switch



Pressure sensors type PK

Easy switch point adjustment via two setting rings allowing optimum read-out.

Mechanical locking prevents inadvertent switch point manipulation.

Stainless steel measuring cell without any seal.



Type	Measuring range Relative pressure [bar]	P _{overload} max. (static) [bar]	Order no.	Price
Adjustable Pressure Switch, M12 connector - output adjustable. 2 x NO, PNP				
	0...400	600	PK7520	\$448.00
	0...100	200	PK7522	\$436.00
	0...25	60	PK5523	\$334.00
	0...10	25	PK7524	\$436.00
M12 connector - output adjustable. 2 x NO/NC, PNP (complementary)				
	0...400	600	PK6520	\$448.00
	0...250	400	PK6521	\$436.00
	0...100	200	PK6522	\$436.00
	0...25	60	PK6523	\$436.00
	0...10	25	PK6524	\$436.00

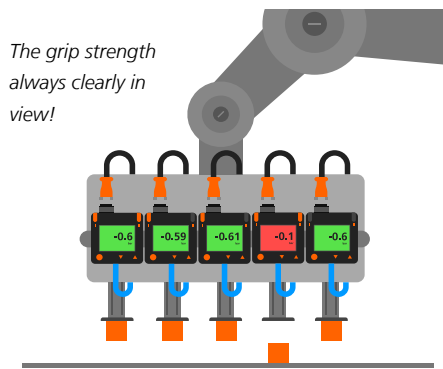

Pneumatic pressure sensors

PQ series - IO-link pressure transmitter & switch



The grip strength always clearly in view!

The current status can be identified quickly and clearly due to the red / green colour change.

Type	Measuring range Relative pressure [bar]	Connection	Order no.	Price
Output function 1 x NO/NC programmable + 1 x 4...20 mA output				
	-1...10	M8 connector	PQC812	\$231.00
	-1...1	M8 connector	PQC816	\$231.00
Output function 2 x NO/NC programmable				
	-1...10	M8 connector	PQS812	\$223.00
	-1...1	M8 connector	PQS816	\$223.00

PQ series - IO-link differential pressure transmitter & switch - WATCH THIS SPACE!

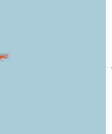

Type	Measuring range Relative pressure [bar]	Connection	Order no.	Price
Differential pressure transmitter, output 1 x PNP/NPN prog + 1 x 4...20 mA output				
	-1...10	M8 connector	PQD384	POA
	-1...1	M8 connector	PQD389	POA

Submersible pressure transmitters type PS

PS Sensors



Measuring range [bar]	Output	Cable [m]	Order no.	Price
For high resistance to media, CE approval				
0...0.25	4...20 mA	FEP, 5 m	PS4208	\$1,498.00
0...0.25	4...20 mA	FEP, 10 m	PS4408	\$1,599.00
0...0.25	4...20 mA	PUR, 5 m	PS3208	\$1,066.00
0...0.6	4...20 mA	PUR, 10 m	PS3407	\$1,174.00
0...0.6	4...20 mA	PUR, 15 m	PS3427	\$1,211.00
0...0.6	4...20 mA	FEP, 10 m	PS4407	\$1,599.00
0...0.6	4...20 mA	FEP, 20 m	PS4506	\$1,800.00
0...0.6	4...20 mA	PUR, 30 m	PS3607	\$1,293.00
0...1	4...20 mA	PUR, 15 m	PS3417	\$1,211.00
0...1	4...20 mA	FEP, 15 m	PS4417	\$1,699.00
0...1	4...20 mA	FEP, 30 m	PS4607	\$2,001.00
For hazardous areas, CE, Ex, GL approvals				
0...1	4...20 mA	FEP, 15 m	PS317A	\$2,212.00

Accessories

Type	Description	Order No.	Price
	Cable clamp fastener	E30399	\$58.00
	Filter element for submersible pressure transmitters	E30400	\$16.00
	Splitter box	E30401	\$215.00
	Additional weight for submersible pressure transmitters	E30402	\$131.00

Absolute pressure sensors

PT series

Pressure transmitters type PT

For absolute pressure measurement.

Transmitters with fixed measuring range.

Stainless steel measuring cell without any seal.

Type	Measuring range Relative pressure [bar]	P_{overload} max. [bar] static	Order no.	Price
Absolute pressure transmitter, G1/4 Connection, Output function 4...20 mA				
	0...1	2	PT0507	\$307.00
	0...1.6	3.2	PT0517	\$299.00

Level sensors and mounting accessories



Learn more



LMT Hygienic Point Level Sensors

LMT level sensors

Flexible mounting.

Shock & vibration resistant in a robust stainless steel housing.

Hygienic approvals EHEDG, 3A, FDA.

Versions available as overflow prevention to WHG*.

Complementary switching outputs.



Process connection	Installation length [mm]	Medium temp [°C]	Article no.	Price
M12 connection · output function 2 x NO/NC complementary (water based media)				
G 1/2	11	-40...100	LMT100	\$482.00
G 1/2	38	-20...100	LMT102	\$544.00
G 1/2	153	-20...100	LMT104	\$632.00
G 1/2	253	-20...100	LMT105	\$643.00
M12 connection · output function 2 x NO/NC complementary (viscous media and powders)				
G 1/2	11	-40...100	LMT110	\$482.00
G 1/2	11	-40...100	LMT121	\$517.00
G 1/2	-	-40...250	LMH600	\$826.00



Accessories

Type	Description	Article no.	Price
	Screw-in adapter, G 1/2 female – G 3/4 male	E43302	\$87.00
	Screw-in adapter, G 1/2 female – G 1 male	E43303	\$158.00
	Screw-in adapter, G 1/2 female – 3/4 NPT	E43313	\$98.00
	Aseptoflex Vario adapter Clamp 1-1.5" O-ring EPDM*	E33401	\$117.00
	Aseptoflex Vario adapter Clamp 2" O-ring EPDM*	E33402	\$117.00
	Welding adapter for process sensors G1/2-welding spherical	E30055	\$88.00

LMC Industrial Point Level Sensor

LMC level sensors

Flexible mounting.

Shock & vibration resistant in a robust stainless steel housing.

Versions available as overflow prevention to WHG*.

Complementary switching outputs.



Process connection	Installation length [mm]	Medium temp [°C]	Article no.	Price
Applications: water, hydrous media M12 connector · output function NO/NC complementary				
G 1/2	12	-25...100	LMC100	\$368.00
G 1/2	21	-25...100	LMC400	\$368.00
1/2 NPT	34	-25...100	LMC500	\$368.00
Applications: oils, oil-based media M12 connector · output function NO/NC complementary				
G 1/2	12	-25...100	LMC110	\$368.00
1/2 NPT	34	-25...100	LMC510	\$368.00
G 1/2	-	-40...250	LMH610	\$826.00



Installation example LMC400: Rear installation of the LMC400 sensor in the pipe permits variable installation depths.

Accessories

Type	Description	Article no.	Price
	Welding adapter, G 1/2, Ø 26.4 mm	E43375	\$30.00
	Flat seal, 26.5 x 21.3 x 1.5 mm	E43376	\$10.00



Radar sensor

Designed for F&B, water treatment applications





- 80 GHz frequency, continuous level monitoring
- 0 - 10m range, high accuracy (+/-2mm FS)
- Resolution 1mm
- Polished SS316L housing, sealed to IP69K
- Designed for CIP/SIP applications



Type	Measuring Range [m]	Outputs	Medium Temperature [°C]	IP Rating	Order no.	Price
Hygienic design to IP69k protection, use in enclosed tanks						
	10m (15m possible)	IO-Link 4...20 mA Binary switch	-40°C...150°C	IP69k	LW2720	\$3,194.00
Designed to IP69k protection (follow installation guidelines)						
	10m (15m possible)	IO-Link 4...20 mA Binary switch	-40°C...150°C	IP69k	LW2120	\$2,879.00

Accessories

Description	Order no.	Price
 Hygienic weld socket Ø50 mm – G 1 Aseptoflex Vario, with leakage port	E30130	\$129.00
 Tri-clamp DN25...DN40 (1...1.5") – G 1 Aseptoflex Vario, with leakage port	E33208	\$135.00
 Tri-clamp DN50 (2") – G 1 Aseptoflex Vario, with leakage port	E33209	\$155.00

FCM FDA

Hygienic Cleanable EC 1935/2004

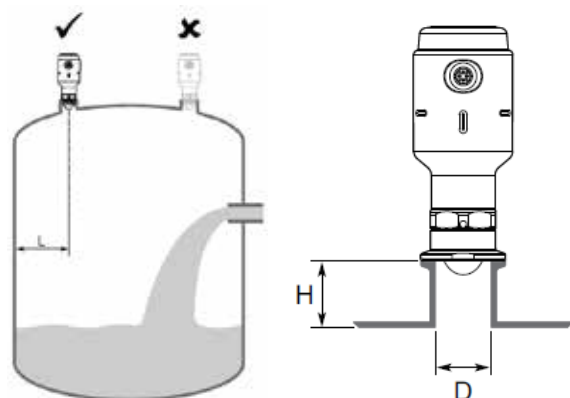

Installation guidelines

Recommended 1/2 of the tank radius
Minimum distance to Tank Wall, L= 200 mm.

Nozzle Diameter (D)	Maximum nozzle height (H)
40 mm	150 mm
50 mm	200 mm
80 mm	300 mm
100 mm	400 mm
150 mm	600 mm

Level sensors type LR

Continuous measurement level sensors



Type LR level sensors
Display and handling on
the unit or via IO-Link.
As an option with
analogue output or up to
four switching outputs.



LR type level transmitter
For industrial applications.
Analogue output scalable 4...20
mA / 0...10 V.
Protection rating IP 69K.
Easily adjustable via IO-Link.



Coaxial pipes for LR level
sensors with G 3/4 male,
industrial applications.
Material stainless steel
(1.4301 / 304)

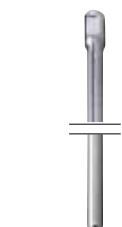

Note: Ensure the probe you select is
compatible with the amplifier!

*Note: for use with
Hygienic probes



Process connection	Outputs	Display	IP Rating	Order no.	Price
M12 connector - I/O Link Programmable					
G 3/4	2 Sw points	4 Digit LED	IP67	LR7000	\$827.00
G 3/4	2 Sw points	-	IP69k	LR7020	\$705.00
G 3/4	4 Sw points	4 Digit LED	IP67	LR8000	\$960.00
G 3/4	1 Sw, 1 analogue	4 Digit LED	IP67	LR3000	\$979.00
G 3/4	1 Sw, 1 analogue	-	IP69k	LR3020	\$827.00
M12 connector - I/O Link Programmable, SS316L					
G 3/4	1 Sw, 1 analogue	4 Digit LED	IP69k	LR2050	\$1,294.00
M12 connector - I/O Link Programmable, IP69K, SS316L ,G1 Aseptoflex vario					
G 1	1 Sw & 1 analogue, or 2 Sw	4 Digit LED	IP69k	LR2750	\$1,934.00

Accessories

Length	Design	Material	Order No.	Price
240mm	Industrial	SS316L	E43203	\$39.00
-	Coaxial tube	SS304	E43211	\$146.00
450mm	Industrial	SS316L	E43204	\$55.00
-	Coaxial tube	SS304	E43212	\$166.00
700mm	Industrial	SS316L	E43205	\$73.00
-	Coaxial tube	SS304	E43213	\$188.00
1,000mm	Industrial	SS316L	E43207	\$103.00
-	Coaxial tube	SS304	E43214	\$217.00
1,200mm	Industrial	SS316L	E43208	\$123.00
-	Coaxial tube	SS304	E43215	\$260.00
1,400mm	Industrial	SS316L	E43209	\$146.00
-	Coaxial tube	SS304	E43216	\$303.00
1,600mm	Industrial	SS316L	E43210	\$166.00
-	Coaxial tube	SS304	E43217	\$347.00

Length	Design	Material	Order No.	Price
150mm	Hygienic	SS316L	E43345	\$129.00
300mm	Hygienic	SS316L	E43346	\$155.00
500mm	Hygienic	SS316L	E43340	\$191.00
700mm	Hygienic	SS316L	E43347	\$223.00
1,000mm	Hygienic	SS316L	E43341	\$260.00
1,200mm	Hygienic	SS316L	E43334	\$256.00
1,500mm	Hygienic	SS316L	E43348	\$295.00
2,000mm	Hygienic	SS316L	E43342	\$347.00

Description	Order no.	Price
Flange plate, LR 65-80, stainless steel 303	E43202	\$89.00
G 3/4" Welding adaptors, ø50mm	E30009	\$108.00
Sealing plug (FDA G1)	E30128	\$111.00
Aseptoflex Vario adapter Clamp 1-1.5" O-ring EPDM*	E33201	\$125.00
Aseptoflex Vario adapter Clamp 2" O-ring EPDM*	E33202	\$147.00

Maintenance-free capacitive level measurement





Capacitive level sensors







- Optimised for use in hydraulic oils and coolants
- No maintenance necessary, free from mechanical parts
- Easy adjustment and setting of the output function via inductive teach button
- 🔍 2 configurable switching outputs defined by media or temperature
- 🔍 Adjustment to different media (e.g. water/oil)



Type	Probe length (mm)	Medium Factory Setting	Output	Order no.	Price
Hydraulic level probe for water, oils or coolants, -25...85°C					
	132	Water based	2 x DO	LI5131	\$322.00
	273	Water based	2 x DO	LI5132	\$340.00
	481	Water based	2 x DO	LI5133	\$358.00
	737	Water based	2 x DO	LI5134	\$376.00
	132	Oil	2 x DO	LI2131	\$427.00
	273	Oil	2 x DO	LI2132	\$443.00
	481	Oil	2 x DO	LI2133	\$458.00

Type	Probe length (mm)	Temperature [°C]	Output	Order no.	Price
Combined level and temperature hydraulic level probe					
	472 mm	0...70 (90 for 1 hr)	1xDO, 1x4-20	LT3023	\$1,097.00
	262 mm	0...70 (90 for 1 hr)	4 x DO	LT8022	\$1,046.00
	472 mm	0...70 (90 for 1 hr)	4 x DO	LT8023	\$1,105.00
	728 mm	0...70 (90 for 1 hr)	4 x DO	LT8024	\$1,164.00

Type	Description	Order no.	Price
Mounting accessories			
	Mounting clamp for level sensors Ø 16 mm	E43000	\$11.00
	Mounting clamp for level sensors Ø 16 mm	E43016	\$39.00
Mounting adapters			
	Mounting adapter, G 3/4, stainless steel	E43003	\$97.00
	Installation adapter for level sensors, D16, stainless steel	E43004	\$105.00
	Flange plate for level sensors, 65-80 mm, anodised aluminium	E43006	\$87.00

Maintenance-free capacitive level measurement



Capacitive level sensors

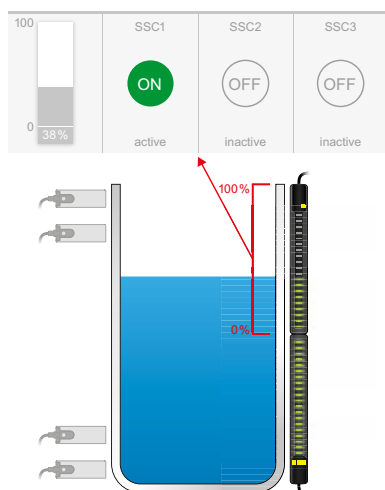

- Continuous level monitoring from outside the process
- No stress caused by the medium thanks to non-contact detection
- Three point level positions in one sensor
- Deposits can be detected and signalled to improve quality of the process
- Several KQ10 units can be linked via IO-Link

KQ10 for continuous Level monitoring - 3 programmable set points



Type	Power Supply	Ambient temp	Protection rating	Connection	Order no.	Price
Capacitive point level via continuous level monitoring - PNP/NPN						
	18-30 VDC	-20...80°	IP67	2m cable, 5-pole	KQ1000	\$584.00
	18-30 VDC	-20...80°	IP67	0.1m cable, M12 connector, 5-pole	KQ1001	\$584.00



Type	Description	Order no.	Price
	Mounting adapter for flat surfaces	E12675	\$55.00
	Mounting adapter for pipes	E12676	\$52.00
	Surface mount tape for KQ10	E12677	\$104.00
	PA cable tie, 760mm long (5 piece pack)	E10880	\$14.00
	2m, Black, PUR jumper, 5-pole	EVC058	\$73.00
	5m, Black, PUR jumper, 5-pole	EVC059	\$84.00

Type KQ point level sensors



Capacitive sensors in small plastic rectangular housing. Easy installation with mounting adapters and fixing straps.

Design	Output stage	Sensing range [mm]	Housing material	Connection	Order no.	Price
PerformanceLine · M12 connector · 3 wires, IO-Link Com 2						
48 x 20 x 7	PNP	12 nf	PBT	cable 2 m	KQ5100	\$119.00
Connection cable with M12 connector · 3-wire						
48 x 20 x 14	PNP	12 nf	PBT	M12	KQ6005	\$230.00

Radar distance sensor

Radar sensor for harsh environmental and weather conditions

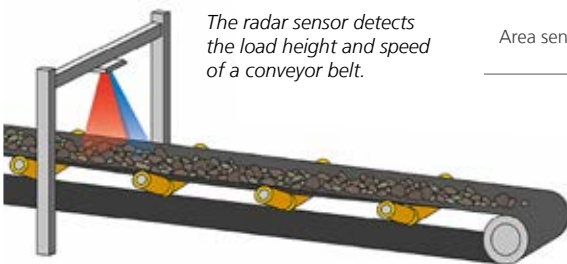

The radar sensor detects the load height and speed of a conveyor belt.

- Long ranges and a wide temperature range
- Reliable measurements even in precipitation, fog, dust and dirt
- Simultaneous detection of distance and speed
- Adaptable to specific applications thanks to various operating modes
- Intuitive set-up and visualisation of the measured data using the ifm Vision Assistant software

Type	Aperture angle horizontal x vertical [°]	Frequency [GHz]	Outputs (2x configurable)	Order no	Price
Distance sensor	40 x 20	77...81	IO-Link, binary, 4...20 mA, 0...10 V	R1D200	\$1,521.00
Distance sensor, wide adjustable angle	140 x 30	77...81	IO-Link, binary, 4...20 mA, 0...10 V	R2D200	\$1,874.00
Area sensor, wide angle	140 x 30	77...81	IO-Link, binary	R2D210	\$1,874.00

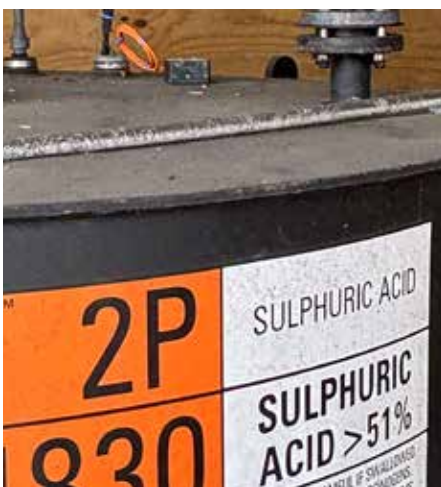

Accessories

Type	Description	Order no.	Price
	Mounting bracket for radar sensors	E23009	\$90.00
	Mounting bracket for radar sensors	E23010	\$86.00
	Mounting bracket for radar sensors	E23011	\$71.00
	Mounting bracket for radar sensors	E23011	\$71.00
	Radar corner reflector	E23013	\$163.00

Radar common applications

Radar sensor for harsh environmental and weather conditions



Presence and distance control

- Detection of vehicles in car wash stations
- Level detection of stockpiles, bulk material and fluids
- Detection of distances and heights



Door, barrier and gate automation

- Automation of industrial doors, barriers, toll gates
- Detection of vehicles on loading docks
- Cross traffic suppression



Collision avoidance and obstacle detection

- Area monitoring / blind spot detection on off-road vehicles, industrial trucks and municipal vehicles, lifting platforms, etc.
- Stand-alone or in combination with other sensors



What is possible to detect



Radar Distance Sensors	
	Non contact load height, and simultaneous belt speed detection
	Position detection of vehicles in water spray or rain
	Level detection of liquid and solid media, even through plastic
	Automation of gates and barriers, with cross traffic masking
Radar Range Sensors	
	Obstacle detection and collision warning in areas with poor visibility
	Distance and height monitoring, even in dusty environments
	Precise detection of distance between a vehicle and obstacles

Radar sensor measures distance, position and speed, even in poor visibility

IP69K

IO-Link

Digital communication to the sensor

Analogue integration

Digital communication to the sensor

Submersible pressure transmitters type PS

PS Sensors



Measuring range [bar]	Output	Cable [m]	Order no.	Price
For high resistance to media, CE approval				
0...0.25	4...20 mA	FEP, 5 m	PS4208	\$1,498.00
0...0.25	4...20 mA	FEP, 10 m	PS4408	\$1,599.00
0...0.25	4...20 mA	PUR, 5 m	PS3208	\$1,066.00
0...0.6	4...20 mA	PUR, 10 m	PS3407	\$1,174.00
0...0.6	4...20 mA	PUR, 15 m	PS3427	\$1,211.00
0...0.6	4...20 mA	FEP, 10 m	PS4407	\$1,599.00
0...0.6	4...20 mA	FEP, 20 m	PS4506	\$1,800.00
0...0.6	4...20 mA	PUR, 30 m	PS3607	\$1,293.00
0...1	4...20 mA	PUR, 15 m	PS3417	\$1,211.00
0...1	4...20 mA	FEP, 15 m	PS4417	\$1,699.00
0...1	4...20 mA	FEP, 30 m	PS4607	\$2,001.00
For hazardous areas, CE, Ex, GL approvals				
0...1	4...20 mA	FEP, 15 m	PS317A	\$2,212.00

Accessories

Type	Description	Order No.	Price
	Cable clamp fastener	E30399	\$58.00
	Filter element for submersible pressure transmitters	E30400	\$16.00
	Splitter box	E30401	\$215.00
	Additional weight for submersible pressure transmitters	E30402	\$131.00

Laser distance sensors - for Opaque liquids (not transparent)



Range [mm]	Laser class	Outputs	Order no.	Price
Distance detection				
200...10,000	2	PNP + 4...20 mA	O1D100	\$861.00
200...10,000	2	DC 1 x PNP	O1D101	\$861.00
200...10,000	2	PNP + 4...20 mA	O1D105	\$861.00
300...6,000	1	PNP + 4...20 mA	O1D155	\$861.00
200...10,000	2	PNP + 4...20 mA, IO-Link prog	O1D120	\$861.00
Level detection				
200...10,000	2	PNP + 4...20 mA	O1D300	\$869.00

Accessories

Type	Description	Order No.	Price
	O1D Alignment + Mounting adapter SS316L ø12mm	E2D101	\$66.00
	O1D Hygienic Mounting adapter SS316L/G1	E21224	\$353.00
	O1D Hygienic Tri-Clamp adapter, SS316L, clamp 1-1.5"	E33601	\$148.00
	O1D Protective window: PMMA transparent	E21133	\$69.00
	O1D Hygienic Weld adapter, SS316L, G1 ø50mm	E30013	\$93.00



Ultra-sonic sensors

Ranges vary from 40mm...8m



Design	Range [mm]	Output	Setting	Order no.	Price
Diffuse sensor · 3-wire DC, 4-pole					
M18 x 60mm	300	PNP	IO-Link	UGT524	\$443.00
Diffuse sensor · 4-wire DC, 4-pole					
M18 cube	300	PNP + 4...20 mA	Button	UGT580	\$487.00
M18 cube	300	PNP	Button / IO-Link	UGT592	\$491.00
M18 cube	1,200	PNP + 4...20 mA	Button	UGT584	\$487.00
M18 cube	1,200	PNP, prog	Button / IO-Link	UGT594	\$491.00
Diffuse sensor · 4-wire DC, 4-pole, IO-Link, PBT plastic					
M18 x 98mm	150...1,600	2 x PNP, NO/NC Prog	Button, IO-Link	UGT203	\$532.00
M18 x 98mm	150...1,600	PNP + 4...20 mA	Button, IO-Link	UGT204	\$532.00
Diffuse sensor · 4-wire DC, 4-pole					
M18 x 98mm	2,200	2 x PNP	Button, IO-Link	UGT512	\$593.00
M18 x 98mm	2,200	PNP + 4...20 mA	Button, IO-Link	UGT513	\$593.00
M18 x 98mm	2,200	PNP + 0...10 V	Button, IO-Link	UGT514	\$593.00
Diffuse sensor · 4-wire DC, 4-pole					
M30 X 1.5	3,500	2 x PNP	Button, IO-Link	UIT500	\$779.00
M30 X 1.5	3,500	PNP + 4...20 mA	Button, IO-Link	UIT501	\$864.00
M30 X 1.5	6,000	PNP + 4...20 mA	Button, IO-Link	UIT504	\$1,006.00
M30 X 1.5	8,000	PNP + 4...20 mA	Button, IO-Link	UIT507	\$1,176.00
Diffuse sensor · 4-wire DC, 4-pole - stainless steel, IP69K					
M30 X 1.5	2,500	PNP + 4...20 mA	IO-Link	UIT301	\$1,170.00



Ultrasonic level application tips:

While an attractive option price-wise for level control, we recommend you avoid:

- Open air settings - where wind can attenuate sound waves
- Avoid fumes/steam - ultrasonics are designed to be used in clean air
- Avoid Fast fill / discharge applications - ultrasonics respond relatively slowly



Accessories

Type	Description	Order no.	Price
	Mounting set, Ø 18.5 mm clamp mounting, high-grade stainless steel (M10 cap screw)	E20870	\$43.00
	Mounting set, Ø 30.2 mm clamp mounting, high-grade stainless steel	E20874	\$43.00
	Mounting rod, 100 mm, Ø 12 mm M10 thread, stainless steel	E20938	\$17.00
	Angle bracket for type M30, stainless steel	E10737	\$10.00
	Sound tube M18, POM	E23000	\$64.00
	Sound tube M30, POM	E23007	\$71.00

Flow sensors and mounting accessories



Learn more



SM Foodmag - magnetic-inductive volumetric flow meters, simultaneously detects flow, conductivity and temperature – all at a single measuring point.



SU Puresonic can reliably measure the flow rate of water even at very low conductivity levels.



SD flow sensor, 4 in 1: flow meter determines the consumption of four industrial gases

Industrial Flow sensors

Industrial Flow sensors type SM



- For water based conductive media $>20 \mu\text{S}/\text{cm}$ / viscosity: $< 70 \text{ mm}^2/\text{s}$ (40 °C)
- IO-Link communication for fast setup and maximum data feedback
- SS316L stainless steel body
- IP 67 water tight protection rating



Measuring range Flow [l/min]	Process Connection	Medium Temperature [C]	Order no.	Price
M12 connector · 24 vDC · outputs 2 x switch/analogue (4/20 mA) · EPDM seals				
0.005...3	G1/4	-20...90	SM4120	\$1,410.00
0.1...35	G1/2	-20...90	SM6120	\$1,324.00
-	G3/4	-20...90	SM7120	\$1,566.00
0.2...150	G1	-20...90	SM8120	\$1,761.00
-	G2	-10...90	SM9100	\$1,989.00
5...600	G2	-10...90	SM2100	\$2,277.00
5...900	G2	-10...90	SM2130	\$2,353.00

Industrial SM accessories

Process adapters for type SM



Process connection	Device connection	Material	Order no.	For sensor type	Price
R 1/2	G 1/2	316L-SS	E40199	SM6xxx	\$140.00
G 1/2	G 1/2	316L-SS	E40213	SM6xxx	\$161.00
G 3/4	G 1/2	316L-SS	E40189	SM6xxx	\$120.00
R 1/2	G 3/4	316L-SS	E40178	SM7xxx	\$138.00
G 1/2	G 3/4	316L-SS	E40214	SM7xxx	\$164.00
G 3/4	G 3/4	316L-SS	E40216	SM7xxx	\$167.00
R 1/2	G 1	316L-SS	E40179	SM8xxx	\$140.00
G 3/4	G 1	316L-SS	E40215	SM8xxx	\$145.00
G 1	G 1	316L-SS	E40217	SM8xxx	\$178.00
1,5" Victaulic	G 2	316L-SS	E40227	SM9xxx, SM2xxx	\$529.00
R 2	G 2	316L-SS	E40231	SM9xxx, SM2xxx	\$528.00
G 1 1/2	G 2	316L-SS	E40230	SM9xxx, SM2xxx	\$464.00
Flange DN50	G 2	316L-SS	E40240	SM9xxx, SM2xxx	\$508.00

Grounding clamp for type SM



Description	Material	Order no.	For sensor type	Price
SM Grounding clamp	316L-SS	E40234	SMxxxx	\$22.00

Hygienic Flow sensors type SMF

Hygienic Flow sensors type SMF



BODY							
Nominal diameter	Measuring range flow [m ³ /h]	Factory Setting Range (ASP/AEP)	Display (metric units)	Price	NO display (metric & imperial units)	Price	Weight
DN15	0.06 ... 6 m ³ /h	0 ... 2 m ³ /h	SMF120	\$4,498.00	SMF150	\$4,168.00	3.6 kg
DN25	0.15 ... 18m ³ /h	0 ... 4 m ³ /h	SMF220	\$4,709.00	SMF250	\$4,379.00	3.7 kg
DN40	0.3 ... 45 m ³ /h	0 ... 11 m ³ /h	SMF320	\$4,955.00	SMF350	\$4,624.00	4,6kg
DN50	0.6 ... 72 m ³ /h	0 ... 18 m ³ /h	SMF420	\$5,113.00	SMF450	\$4,782.00	6,1 kg
DN65	1.2 ... 120 m ³ /h	0 ... 30 m ³ /h	SMF520	\$5,478.00	SMF550	\$5,148.00	7 kg
DN80	1.8 ... 180 m ³ /h	0 ... 45 m ³ /h	SMF620	\$5,819.00	SMF650	\$5,489.00	7,9 kg
DN100	3.0 ... 300 m ³ /h	0 ... 70 m ³ /h	SMF720	\$6,650.00	SMF750	\$6,320.00	9,9kg
DN125	4.5 ... 450 m ³ /h	0 ... 110 m ³ /h	SMF820	\$7,387.00	SMF850	\$7,056.00	15 kg
DN150	6.0 ... 600 m ³ /h	0 ... 160 m ³ /h	SMF920	\$8,260.00	SMF950	\$7,930.00	17,25 kg



Would you like to find a suitable sensor including accessories?

Build a customised solution for your system consisting of sensor, process adapter, seals and more now!



Scan to visit the SMF solution builder

NOTE: RJT, BSM adaptors available on request.



SMF Seals

Sealing						
Nominal diameter	EPDM	Price	FKM	Price	VQM (silicone)	Price
DN15	E40560	\$132.00	E40540	\$132.00	E40570	\$132.00
DN25	E40561	\$134.00	E40541	\$134.00	E40571	\$134.00
DN40	E40562	\$137.00	E40542	\$137.00	E40572	\$137.00
DN50	E40563	\$148.00	E40543	\$148.00	E40573	\$148.00
DN65	E40564	\$162.00	E40544	\$162.00	E40574	\$162.00
DN80	E40565	\$169.00	E40545	\$169.00	E40575	\$169.00
DN100	E40566	\$200.00	E40546	\$200.00	E40576	\$200.00
DN125	E40567	\$252.00	E40547	\$252.00	E40577	\$252.00
DN150	E40568	\$300.00	E40548	\$300.00	E40578	\$300.00

Hygienic Flow sensors type SMF

SMF Process connections



- Robust magnetic-inductive flow meter designed for F&B applications
- IO-Link communication for fast setup and maximum data feedback
- Reduces the need for measuring points by providing flow rate, total volume, temperature and conductivity
- IP69K water tight protection rating

Process Connection								
Nominal diameter	CLAMP ISO 2852	Price	CLAMP DIN 32676 (series A)	Price	Weld-in flange (EN10357 series A)	Price	Milk pipe fitting DIN11851	Price
DN15	-	-	E40490	\$519.00	-	-	E40500	\$495.00
DN25	E40481	\$551.00	E40491	\$551.00	-	-	E40501	\$535.00
DN40	E40482	\$570.00	E40492	\$570.00	E40472	\$391.00	E40502	\$563.00
DN50	E40483	\$608.00	E40493	\$608.00	E40473	\$420.00	E40503	\$596.00
DN65	E40484	\$666.00	E40494	\$666.00	E40474	\$437.00	E40504	\$671.00
DN80	E40485	\$730.00	E40495	\$730.00	E40475	\$489.00	E40505	\$771.00
DN100	E40486	\$848.00	E40496	\$848.00	E40476	\$651.00	E40506	\$1,620.00
DN125	E40487	\$1,678.00	E40497	\$1,678.00	-	-	E40507	\$2,628.00
DN150	E40488	\$2,616.00	E40498	\$2,616.00	-	-	E40508	\$3,272.00

Process Connection										
Nominal diameter	DIN 11864-2A hygienic flange	Price	CLAMP DIN 32676 (series C)	Price	Weld-in flange (EN10357 series C)	Price	Weld-in flange (EN10357 series D)	Price	SMS Thread Connection	Price
DN15	-	-	E40610	\$519.00	-	-	-	-	-	-
DN25	-	-	-	-	-	-	-	-	E40511	\$587.00
DN40	E40522	\$1,317.00	E40612	\$570.00	E40622	\$391.00	E40632	\$391.00	E40512	\$647.00
DN50	E40523	\$1,454.00	E40613	\$608.00	E40623	\$420.00	E40633	\$420.00	E40513	\$687.00
DN65	E40524	\$1,545.00	E40614	\$666.00	E40624	\$437.00	-	-	E40514	\$783.00
DN80	E40525	\$1,950.00	E40615	\$730.00	E40625	\$489.00	-	-	E40515	\$917.00
DN100	E40526	\$2,042.00	E40616	\$848.00	E40626	\$651.00	E40636	\$651.00	E40516	\$1,666.00
DN125	E40527	\$3,183.00	-	-	-	-	-	-	-	-
DN150	E40528	\$4,616.00	E40618	\$2,616.00	-	-	-	-	-	-



SM Grounding clamp, 316L-SS

Accessories

Type	Description	Order no.	Price
	Replacement LED screen for SMF	E40581	\$2,069.00
	Replacement LED screen for SMF	E40582	\$1,738.00
	SM Grounding clamp, 316L-SS	E40234	\$22.00

IMPORTANT!

Always use a grounding clamp.

Flow sensors type SU

Hygienic ultrasonic flow meter - ideal for non-conductive liquids



Ideal for non-conductive liquids - oil, diesel, glycol, demineralised water etc

Process connection	Measuring range	Medium temperature [°C]	(Water, oil, glycol) Order no	Price	(Water)	Price
	[l/min]				Order no	
IO-Link, Output function 2 x \swarrow / \searrow or analogue (4...20 mA / 0...10 V) DC PNP/NPN						
Display and programming push buttons						
Hygienic 1" Tri-Clamp	1...240 L/min	-20...100	-	-	SUH200 ☺	\$1,653.00
Hygienic 2" Tri-Clamp	5...1,000 L/min	-20...100	-	-	SUH400 ☺	\$1,892.00
No-display, programming via IO-Link						
Hygienic 1/2"	1...65	-40...120	-	-	-	-
Hygienic 3/4"	1...75	-40...120	SUH801 ☺	\$1,558.00	-	-
Hygienic 1"	1...240	-40...120	SUH251 ☺	\$1,653.00	SUH200 ☺	\$1,653.00
Hygienic 1 1/2"	3...375	-40...120	SUH301 ☺	\$1,759.00	-	-
Hygienic 2"	5...1,000	-40...120	SUH451 ☺	\$1,892.00	SUH400 ☺	\$1,892.00
Hygienic 2 1/2"	20...2,400	-40...120	SUH501 ☺	\$2,333.00	-	-
Hygienic 3"	25...3,600	-40...120	SUH601 ☺	\$2,755.00	-	-
Hygienic 4"	45...6,000	-40...120	SUH701 ☺	\$3,287.00	-	-

Industrial ultrasonic flow meter - ideal for non-conductive liquids



Process connection	Measuring range	Medium temperature [°C]	(Water, oil, glycol) Order no	Price	(Water)	Price
	[l/min]				Order no	
IO-Link, Output function 2 x \swarrow / \searrow or analogue (4...20 mA / 0...10V) DC PNP/NPN						
Display and programming push buttons						
G 1/2 (DN15)	0.5...65	-20...100	SU6030 ☺	\$1,225.00	SU6020 ☺	\$1,097.00
G 3/4 (DN20)	0.5...75	-20...100	SU7030 ☺	\$1,282.00	SU7020 ☺	\$1,156.00
G 1 (DN25)	1...240	-20...100	SU8030 ☺	\$1,340.00	SU8020 ☺	\$1,215.00
G 1 1/4 (DN32)	1...275	-20...100	SU9030 ☺	\$1,398.00	SU9020 ☺	\$1,274.00
G 2 (DN50)	5...1,000	-20...100	SU2030 ☺	\$1,571.00	SU2020 ☺	\$1,449.00
No-display, programming via IO-Link						
G 1/2 (DN15)	0.5...65	-40...120	SU6050 ☺	\$1,225.00	-	-
G 3/4 (DN20)	0.5...75	-40...120	SU7050 ☺	\$1,282.00	-	-
G 1 (DN25)	1...240	-40...120	SU8050 ☺	\$1,340.00	-	-
G 1 1/4 (DN32)	1...275	-40...120	SU9050 ☺	\$1,398.00	-	-
G 2 (DN50)	5...1,000	-40...120	SU2050 ☺	\$1,571.00	-	-

SU Accessories

Please refer to www.ifm.com/au for mounting accessories related to SU series flow meters. Including mounting adaptors covering:

- G (BSP-P) to R (BSP-T)
- G to NPT
- G to Tri-clamp



Flow sensors type SB, SV & SI

Configurable Industrial Flow Sensor for Water, Oils, Emulsions & Air



Process connection	Measuring range	Medium temp [°C]	Viscosity	Order no	Price
	[l/min]				
Water, Coolants, Oil & Glycol solutions, IO-Link, configurable, digital outputs 2, analogue outputs 1					
G 1/2	0.3...15	0...80	oil viscosity: 10 mm ² /s (40 °C)	SBG232	\$761.00
G 1/2	0.5...25	0...80	oil viscosity: 10 mm ² /s (40 °C)	SBG233	\$761.00
G 3/4	2...100	0...80	oil viscosity: 10 mm ² /s (40 °C)	SBG246	\$914.00
G 1 1/4	4...200	0...80	oil viscosity: 10 mm ² /s (40 °C)	SBG257	\$1,092.00
Oil					
G 3/4	0.5...25 l/min	-10...100	oil (viscosity 46 mm ² /s at 40 °C)	SB2233	\$863.00
G 3/4	1...50 l/min	-10...100	oil (viscosity 10 mm ² /s at 40 °C)	SB1234	\$863.00
G 1	2...100 l/min	-10...100	oil (viscosity 68 mm ² /s at 40 °C)	SB3246	\$1,046.00
G 1 1/2	4...200 l/min	-10...100	oils (viscosity 10 mm ² /s at 40 °C)	SB1257	\$1,219.00

Vortex Water Flow Meter - low cost!

Flow meters type SV
Electronically rotatable
multi-colour display.
Pressure-resistant up to
12 bar.
Medium temperature
-10...90 °C.
Rotatable process
connection.



Measuring range [l/min]	Medium temperature [°C]	Nominal diameter [Ø]	Process connection	Order no.	Price
M12 connector · electrical design DC, 2 x IO-Link Programmable					
1.0...20	-10...90	DN8	G 1/2	SV4200	\$833.00
2.0...40	-10...90	DN10	G 1/2	SV5200	\$851.00
5.0...100	-10...90	DN20	G 3/4	SV7200	\$904.00
M12 connector · electrical design DC 2 x analogue 4...20 mA					
1.0...20	-10...90	DN8	G 1/2	SV4204	\$827.00
2.0...40	-10...90	DN10	G 1/2	SV5204	\$857.00
5.0...100	-10...90	DN20	G 3/4	SV7204	\$911.00

Note: Versions with Rc process connection option are available on request.

SV Accessories

Mounting plate	Material	Order no.	For sensor type	Price
	high-grade stainless steel	E40249	SV Series ¹⁾	\$17.00

Hygienic Flow monitor

Flow sensors type SI
Modular adaptation for
hygienic applications.
Protection rating IP 67 and
IP 69K.



Probe length [mm]	(Liquids) Largest sensitivity [cm/s]	Material	Pressure [bar]	Order no.	Price
M12 connector · G1A / Aseptoflex Vario adapter, -25...95, for SIP process: ...140° c					
38	3...100	SS316L	30	SI6700	\$903.00
55	3...100	SS316L	30	SI6800	\$916.00

Accessories



Process connection	Device connection	Material	Order no.	Price
Clamp 1. 1.5"	Aseptoflex Vario	SS316L	E33201	\$125.00
Clamp 2"	Aseptoflex Vario	SS316L	E33202	\$147.00

Flow sensors type SA & SI

Configurable Industrial Flow Sensor for Water, Oils, Emulsions & Air



Flow sensors type SA

Sensing head rotatable by 345°.

2 switching outputs.

Easy switch-point setting via display

3-pushbutton operating concept.

Fast response time for flow and temperature measurement.

Individual serial number.



Type	Measuring range liquid / gaseous [cm/s]	Medium temp [°C]	Probe length [mm]	Order no.	Price
IO-Link Programmable - electrical design DC PNP/NPN, analogue 4...20 mA					
M18	4...300 / 200...10000	-20...90	45	SA5000	\$819.00
Progressive ring	4...300 / 200...10000	-20...100	100	SA4100	\$850.00
Progressive ring	4...300 / 200...10000	-20...100	200	SA4300	\$879.00

Accessories



Process connection	Device connection	Material	Order no.	Price
Screw Fitting - for SA5xxx series flow sensors				
G 1/4	progressive ring	SS316L	E40099	\$53.00
G 1/2	progressive ring	SS316L	E40096	\$68.00
G 3/4	progressive ring	SS316L	E40134	\$79.00
1/2 NPT	progressive ring	SS316L	E40107	\$60.00
Progressive Ring Fitting - for SA41xx & SA43xx series flow sensors				
G 1/4	progressive ring	SS316L	E40259	\$60.00
G 1/2	progressive ring	SS316L	E40258	\$99.00
G 3/4	progressive ring	SS316L	E40260	\$98.00
R 1/2	progressive ring	SS316L	E40263	\$79.00

Industrial Flow monitor

Flow sensors type SI

Protection rating IP 67.

Robust housing.

Easy to set.



Operating voltage [V]	(Liquids) Largest sensitivity [cm/s]	Material	Pressure [bar]	Order no.	Price
M12 connector					
24vDC, PNP	3...100	SS316L	30	SI5000	\$745.00
24vDC, NPN	3...100	SS316L	30	SI5001	\$763.00
24vDC, 2xNO/NC	3...100	SS316L	300	SI5002	\$792.00
24vDC, 4...20mA	3...100	SS316L	300	SI5004	\$741.00
240vAC, relay	3...100	SS316L	300	SI5006	\$825.00
24vDC, PNP	3...100	SS316L	300	SI5010	\$796.00
24vDC, PNP	3...100	Titanium	100	SI5100	\$1,184.00
24vDC, PNP	3...100	Hastelloy C	300	SI0553	\$1,329.00

Accessories

Process connection	Device connection	Material	Order no.	Price
G 1/4	M18	SS316L	E40099	\$53.00
G 1/2	M18	SS316L	E40096	\$68.00
G 3/4	M18	SS316L	E40134	\$79.00
G 1	M18	SS316L	E40119	\$84.00

Flow sensors

Control monitor for SF series flow sensors



Component guide

Select a control monitor depending on your application. Next, determine an electrical connection, flow probe and process connection.

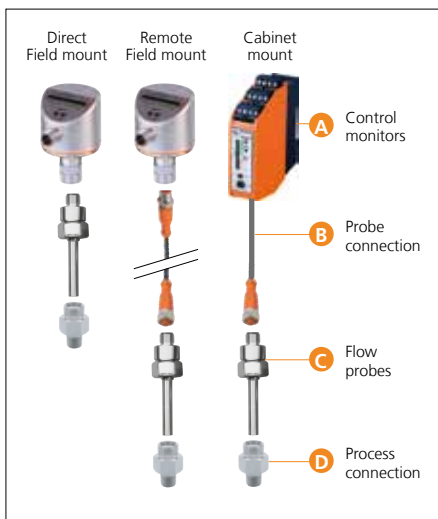

Mounting	Output	Power Supply	Order no.	Price
Remote control monitor				
DIN Rail	Relay	24 VDC	SR0127	\$498.00
DIN Rail	Relay	90-240 VAC	SN0150	\$743.00

Control monitor for flow sensors of the SF series

Operating voltage [V]	Material	Pressure [bar]	Order no.	Price
M12 connector · electrical design DC PNP / AC, relay				
19...36 DC	SS304S15		SR5900	\$586.00
90...240 AC	SS304S15		SR5906	\$641.00

Sensors for connection to control monitor

Sensor length [mm]	Setting range (liquids) [cm/s]	Material	Pressure [bar]	Order no.	Price
M12 · process connection clamp adapter · with flexible immersion depth					
44	3...300 [cm/s]	SS316L	300	SF5200	\$449.00
191	3...300 [cm/s]	SS316L	30	SF6200	\$511.00
M12 · process connection G 1/4 male, adapter · for aggressive media					
12	3...60 [cm/s]	ceramic	30	SF2405	\$573.00
15,5	3...60	ceramic	30	SF3405	\$694.00
44	3...300	titanium	100	SF5700	\$961.00
63	3...300	titanium	100	SF5701	\$1,009.00
93	3...300	titanium	100	SF5702	\$1,144.00
143	3...300	titanium	100	SF5703	\$1,312.00
243	3...300	titanium	100	SF5704	\$1,389.00

Ex rated Approved units for hazardous areas



ATEX approval	Output	Power Supply	Order no.	Price
Remote control monitor				
Group II, category (1) G	Relay	24v DC	SR2301	\$1,762.00

ATEX approval	Process fitting	Material	Order no.	Price
ATEX Rated Flow Sensors, connect to control monitor (see above)				
Group II, category (2) G	G1/4" A	stainless steel (316L)	SF220A	\$593.00

Compressed air sensors

Energy management solution



Learn more



- Energy management system to DIN EN ISO 50001
- **Measures flow, pressure and temperature simultaneously removing the need for multiple sensors**
- Production and transport of compressed air are the second largest cause of energy costs.
- A compressed air system offers many opportunities to reduce operating costs.

Where do the high energy costs originate?

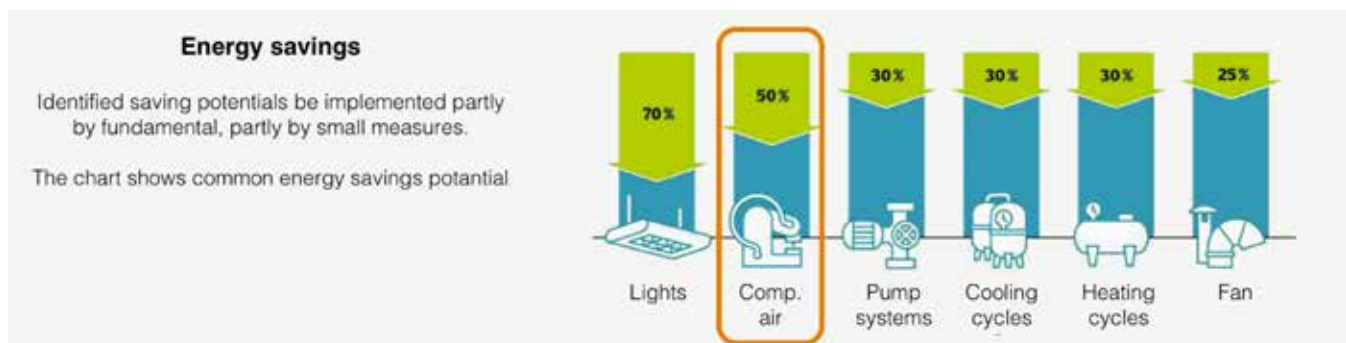

Measurement instrumentation from ifm

Secure benefits with ifm

- Maximum potential for savings using high quality measurement instrumentation
- Use IO-Link independent of higher bus systems
- Documentation available at a click thanks to co-ordinated software
- Simple trend analysis supported by graphics in the monitoring software
- Parameter setting and condition monitoring on the control level for each sensor which has been installed.

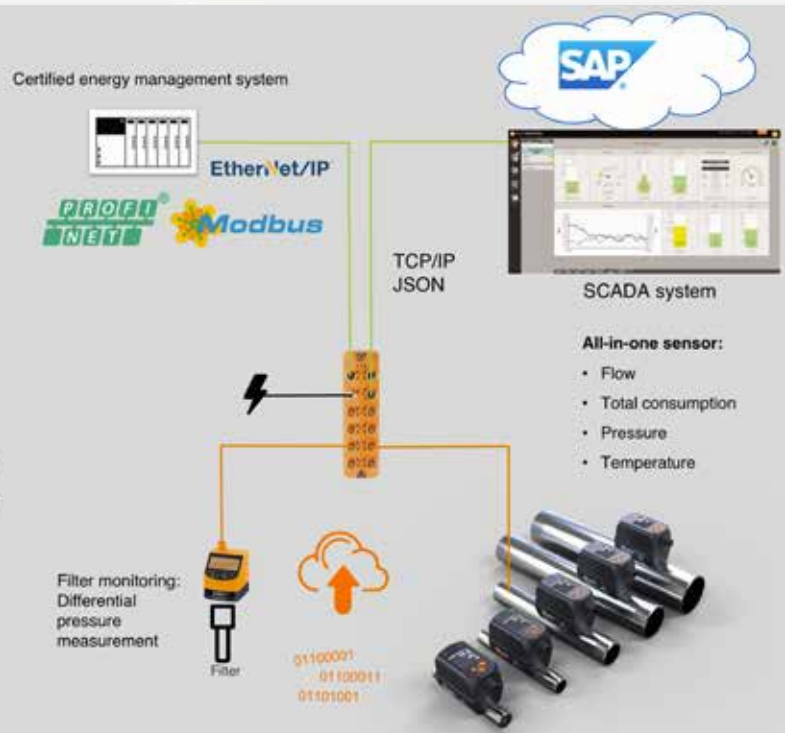

Compressed air sensors

Compressed Air Leak Detector (hand held instrument)



Type	Description Power Supply	Scan to learn more	Order no.	Price
	Hand-held device for the location of leaks, including headphones, power supply and carrying case. 0.1 l/min, at 6 bar, 5 m distance		SDL100	\$12,344.00

Note: This is a non-refundable product.

4 in 1: Flow Meter determines the consumption of four industrial gases



Measuring range [Nm ³ /h]	Pressure rating [bar]	Process connection	Order no.	Price
Defined pipe length for compressed air in industrial use				
0.05...15	16	G 1/4 (DN8)	SD5500	\$1,783.00
0.25...75	16	R 1/2 (DN15)	SD6500	\$1,783.00
0.8...225	16	R 1 (DN25)	SD8500	\$1,890.00
1.4...410	16	R1 1/2 (DN40)	SD9500	\$2,341.00
2.5...700	16	R 2 (DN50)	SD2500	\$2,455.00
Defined pipe length for industrial gases				
N ₂ : 0.04...15 Ar: 0.08...24.04 CO ₂ : 0.04...14.36	16	G 1/4 (DN8)	SD5600	\$1,940.00
N ₂ : 0.24...73 Ar: 0.39...118.2 CO ₂ : 0.24...71.7	16	R 1/2 (DN15)	SD6600	\$1,940.00
N ₂ : 0.8...225.0 Ar: 1.2...366.6 CO ₂ : 0.8...223.6	16	R 1 (DN25)	SD8600	\$2,043.00
Calibration certificate for flow sensors (SD)			Order no.	Price
ISO calibration certificate (6 x calibration points)			ZC0020	\$673.00
DAKKS calibration certificate (6 x calibration points)			ZC0075	\$1,329.00

Large Duct Air Flow Monitor

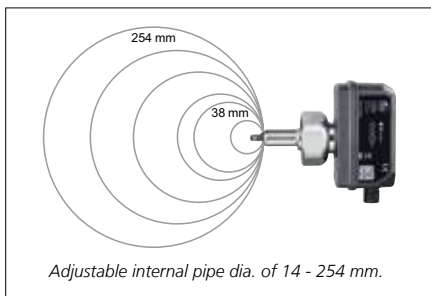

Measuring range	Pressure rating [bar]	Process connection	Order no.	Price
Adjustable pipe diameter				
0.3...26260 m ³ /h	16	G 1 female	SD1540	\$1,876.00

Accessories

Type	Description	Order no.	Price
	Process connection, weld adapter	E40195	\$119.00

Air Flow Switch



Application	Output	Power Supply	Order no.	Price
Air, -10...50 c	3A Relay	24v DC	SL5101	\$268.00
Air, -10...50 c	3A Relay	80-250 AC/DC	SL0301	\$297.00

Temperature sensors & mounting accessories



Learn more



Time for an upgrade?



PROBLEM

- Temperature head transmitters can lead to condensation build-up in poorly sealed terminal heads.
- A serious issue in F&B plant, routinely washed with high pressure hot water. Moisture laden air leads to water condensation accumulation inside the terminal chamber, as temperatures vary.
- Also experienced in outdoor applications. Moisture is a serious problem that leads to calibration loop changes, short circuits and eventually instrument failure.

SOLUTION - technology



- ifm have addressed this issue with state of the art welded head temperature instruments sealed to IP69k.
- The PT1000 sensor element, evaluation electronics and LED display are calibrated to operate as a system solution for your process monitoring
- The one-piece device eliminates wiring issues and moisture ingress, with protection to IP69k



Green = OK Blue = Pre-alert Red = Error!

* German factory calibration must be ordered separately when placing a temperature sensor PO
 This service will result in 4 - 6 weeks delivery delay
 For local calibration by a certified laboratory, we can provide partner information on request



Trust is good, control is better

"We use the TCC sensors for in-process measurement of product temperature, cleaning temperature and sterilisation temperature."



Efficient cooling circuit monitoring

"Critical process states, e.g. reaching of minimum or maximum limit temperatures, can be directly monitored by means of the switching output."



Hygienic F&B applications

"Food safety starts with precise temperature measurement using sensors designed to last in all conditions, especially daily cleaning (CIP)."



Temperature sensors

Industrial Temperature transmitters, 4...20 mA output



Type TA temperature transmitter
Scalable analogue output 4...20 mA
IO-Link. T05 / T09: 1 / 3 s.
Pressure-resistant up to 400 bar.
Accuracy [K]: $\pm 0.3 + (\pm 0.1 \% Ms)$.



Measuring range [°C]	Process connection	Installation depth [mm]	Factory setting [°C]			Price
			0...200 Order no.	-50...150 Order no.	0...100 Order no.	
Analogue output 4...20 mA						
-50...150	G 1/4	25	-	TA2105 ☺	-	\$390.00
		50	-	TA2115 ☺	-	\$395.00
		100	-	TA2135 ☺	-	\$402.00
	G 1/2	150	-	TA2145 ☺	-	\$409.00
		30	-	TA2405 ☺	-	\$414.00
		50	-	TA2415 ☺	TA2417 ☺	\$418.00
		100	-	TA2435 ☺	TA2437 ☺	\$425.00
		150	-	TA2445 ☺	-	\$432.00
		Process connection, probe Ø 6 mm				
-50...200	Ø 6 mm	50	TA2212 ☺	-	-	\$408.00
		100	TA2232 ☺	-	-	\$415.00
		150	TA2242 ☺	-	-	\$422.00
		250	TA2262 ☺	-	-	\$437.00
		350	TA2292 ☺	-	-	\$452.00

Hygienic Temperature transmitter, 4...20 mA output

Type TA temperature transmitter
Operating status indication via LED.
Scalable analogue output 4...20 mA.
Hygienic process connections.
Installation depths of 25 to 150 mm.
IO-Link. T05 / T09: $\leq 0.5 / \leq 2$ s.
Accuracy [K]: $\pm 0.3 + (\pm 0.1 \% Ms)$.



Sensors with fast response times for hygienic applications:

- **Performance:** Fast response times $< 0.25 / < 1$ s [T05/T09] allow precise temperature control.
- **Verified:** Free 3-point factory certificate available online.

Measuring range [°C]	Process connection	Installation depth [mm]	Factory setting [°C]			Price
			0...200 Order no.	-10...150 Order no.	0...100 Order no.	
Process connection G1/2 with sealing cone						
-50...200	G 1/2 with hygienic sealing cone	30	TA2502 ☺	-	-	\$469.00
		50	TA2512 ☺	-	-	\$472.00
		50	-	-	TA2517 ☺	\$472.00
		50	-	TA2511 ☺	-	\$472.00
		100	TA2532 ☺	-	-	\$479.00
		100	-	-	TA2537 ☺	\$479.00
		100	-	TA2531 ☺	-	\$479.00
		150	TA2542 ☺	-	-	\$487.00

Accessories TA25 series hygienic weld fittings

Type	Description	Order no.	Price
	G1/2 - weld fitting (for Tanks)	E43300	\$63.00
	G1/2 - weld fitting (or Pipes)	E43301	\$74.00
	G1/2 - weld fitting (for deep insertion)	E30055	\$88.00

Hygienic Temperature transmitter, 4...20 mA output

Type TA132x temperature transmitters
Are spring loaded for a perfect connection to a thermowell.



Accessories
Process adapters,
thermowells
Page 127



Measuring range [°C]	Process connection	Installation depth [mm]	Factory setting [°C]			Price
			0...200 Order no.	-10...150 Order no.	0...100 Order no.	
Process connection G 3/8 with coupling nut Ø 3 mm						
-50...200	G 3/8 internal thread	83	TA1322 ☺	TA1321 ☺	TA1327 ☺	\$556.00

Temperature sensors

Hygienic Temperature transmitter, 4...20 mA output



Measuring range [°C]	Process connection	Installation depth [mm]	Factory setting [°C]			Price
			0...200 Order no.	-10...150 Order no.	0...100 Order no.	
Process connection 1 - 1.5" Tri clamp						
-50...200	Tri-clamp 1 - 1.5"	30	TA2802	-	-	\$438.00
		50	TA2812	-	-	\$441.00
		100	TA2832	-	-	\$448.00
		150	TA2842	-	-	\$455.00

Industrial temperature transmitter and switch - local display & configuration

Type TN temperature sensor

Selectable colour display. Operation via 3 buttons. 2 x NO / NC or 1 x NO / NC and 1 analogue output 4...20 mA / 0...10 V, scalable. T05 / T09: 1 / 3 s.

Pressure-resistant up to 400 bar.

Accuracy [K]: ± 0.3 + (± 0.1 % Ms).



Accessories
Process adapters,
thermowells
Page 127



Measuring range [°C]	Process connection	Installation depth [mm]	Factory setting [°C]	Price
			-50...150 Order no.	
2 switching outputs or 1 switching and 1 analogue output 4...20 mA or 0...10 V				
-50...150	G 1/2	30	TN2405	\$827.00
		50	TN2415	\$831.00
		100	TN2435	\$838.00
		150	TN2445	\$844.00

Industrial configurable temperature switch

Type TV temperature sensor

Two solutions: Continuous transmission of measured values via IO-Link – and two switching outputs.

Tamper free.

T05 / T09: 1 / 3 s.

Pressure-resistant up to 400 bar.

Accuracy [K]: ± 0.3.



Measuring range [°C]	Process connection	Installation depth [mm]	Order no.	Price
2 switching outputs				
-50...150	G 1/4	25	TV7105	\$372.00
	G 1/2	30	TV7405	\$396.00

Industrial Temperature Switch

Type TK temperature sensor

Easy adjustment of the switch points via two setting rings allowing optimum read-out.

Mechanical lock to prevent accidental adjustment.

T05 / T09: 1 / 3 s.

Pressure-resistant up to 400 bar.

Accuracy [K]: ± 3.



Measuring range [°C]	Process connection	Installation depth [mm]	Order no.	Price
Normally open / normally closed complementary				
-20...140	G 1/4	50	TK6110	\$360.00
2 x NO				
-20...140	G 1/4	50	TK7110	\$360.00
1 x NO / 1 x NC				
-20...140	G 1/4	50	TK7110	\$360.00

Temperature sensors

Temperature transmitter and switch Assembly



Component Guide TR

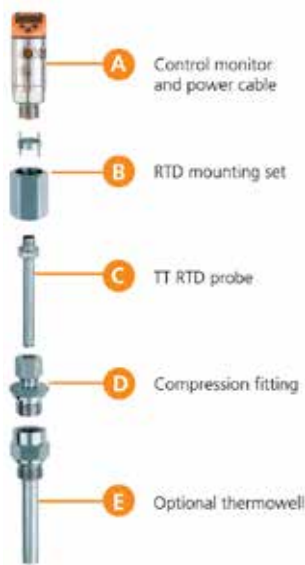

Evaluation electronics type TR

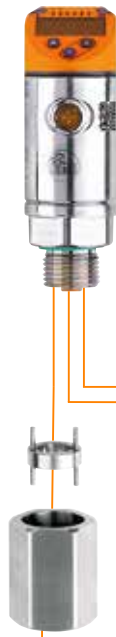

TR evaluation with E30017 mounting set on PT100 / PT1000 probe sensors type TT

Direct connection TR evaluation on PT100 / PT1000 cable sensors type TS

TR or TP evaluation with connection cable on PT100 / PT1000 sensors type TM, TT or TS

Measuring range [°C]	Factory setting [°C]	Process connection	Order no.	Price
1 switching and 1 analogue output 4...20 mA or 0...10 V				
-100...600	-40...300	G 1/2	TR2439	\$757.00
2 switching outputs				
-100...600	-40...300	G 1/2	TR7439	\$659.00

PT100 / PT1000 probe sensors type TT
Cable sensors high temperature type TS



Measuring range [°C]	Ø probe / installation depth [mm]	Order no.	Price	Order no.	Price	
Applications		Industry		Hygienic		
-40...150	Ø 6 / 100mm	TT0281	\$205.00	TT0291	\$220.00	
	Ø 6 / 150mm	TT1281	\$213.00	TT1291	\$226.00	
	Ø 6 / 200mm	TT4281	\$220.00	-	-	
	Ø 6 / 250mm	TT2281	\$228.00	TT2291	\$234.00	
-40...150	Ø 6 / 350mm	TT3281	\$242.00	TT3291	\$248.00	
	Ø 10 / 160mm	TT1081	\$225.00	-	-	
	Ø 10 / 260mm	TT2081	\$240.00	-	-	
	Ø 10 / 360mm	TT3081	\$255.00	-	-	
-100...600	Ø 10 / 560mm	TT5081	\$284.00	-	-	
	Industrial applications					
	-100...600	Ø 6 / 100mm	TS2451	\$265.00	-	-
		Ø 6 / 150mm	TS2452	\$272.00	-	-
Ø 6 / 200mm		TS2453	\$279.00	-	-	
Ø 6 / 250 mm		TS2454	\$287.00	-	-	

PT100 / PT1000 cable sensors type TS



Process connection	Measuring range [°C]
Industrial applications	
Ø 6 mm	-40...90
	-50...250
	-50...250
	-100...600 °C
Bolt-on sensor 12 x 8.7 x 51 mm	-40...90
Bolt-on sensor 12.5 x 8.7 x 47 mm	-40...90
Bolt-on sensor ATEX 10 x 18 x 48 mm	-20...115
M5 screw-in sensor	-30...180
M6 screw-in sensor	-30...180
M8 screw-in sensor	-20...115
M12 x 1,5 external	-30...150



Measured signal converter type TP



Direct connection TP evaluation on PT100 / PT1000 probe sensors type TT, TS or TM

Measuring range [°C]	Factory setting [°C]	Number of inputs & outputs	Order no.	Price
Wash down area (IP69k), Analogue output 4...20 mA				
-100...600	-100...600	Number of digital outputs: 1; Number of analogue outputs: 1	TP2009	\$263.00
	-50...300		TP2008	\$263.00
	-50...150		TP2005	\$263.00
	-10...150		TP2001	\$263.00
	0...100		TP2007	\$263.00
Industrial Analogue output 4...20 mA				
-50...300	-50...150	Number of analogue outputs: 1	TP3231	\$244.00
	-50...300		TP3232	\$244.00
	0...100		TP3237	\$244.00
Industrial Analogue output 0...10 V				
-50...300	0...100	Number of analogue outputs: 1	TP9237	\$244.00

COMPONENT GUIDE TP

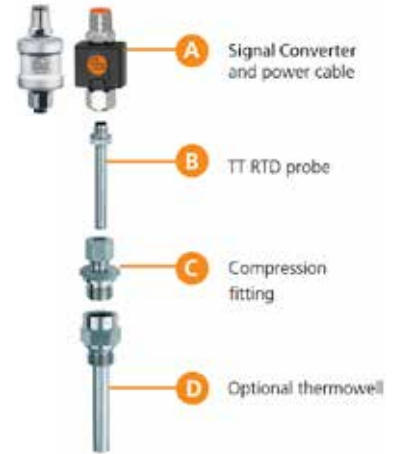

Cable / connector / length [m]	Order no.	Price
PUR / M12 / 5m	TS5289	\$145.00
PTFE / M12 / 0.15m	TS9256 ¹⁾	\$212.00
PTFE / M12 / 2m	TS2256	\$257.00
PTFE / M12 / 2m	TS2451	\$265.00
PUR / M12 / 2m	TS2229	\$138.00
PUR / - / 2m	TS2239	\$94.00
silicone / M12 / 2m		
silicone / - / 5m	TS502A ¹⁾	\$329.00
silicone / M12 / 2m	TS2759	\$157.00
silicone / M12 / 2m	TS2659	\$192.00
silicone / - / 2m	TS285A	\$312.00
silicone / wire end ferrules / 5 m	TS5951	\$177.00

PT100 with process connection type TM



Process connection	Measuring range [°C]	Installation depth [mm]	Order no.	Price
Industrial applications				
G 1/4	-40...150	25mm	TM4101	\$214.00
	-40...150	25mm	TM5101 ¹⁾	\$214.00
	-40...150	50mm	TM4411	\$242.00
	-40...150	50mm	TM5411 ¹⁾	\$242.00
G 1/2	-40...150	100mm	TM4431	\$248.00
	-40...150	150mm	TM4441	\$256.00
	-40...150	250mm	TM4461	\$270.00
	Internal thread M18 x 1.5	-40...125	60mm	TM9950
Hygienic applications				
G 1/2 with sealing cone	-50...140	Flush mount	TM4599	\$286.00
	-40...150	50mm	TM4511	\$296.00
G 1/2 with sealing cone	-40...150	100mm	TM4531	\$303.00
	-40...150	150mm	TM4541	\$310.00
	-40...150	30mm	TM4801	\$265.00
Clamp 1 - 1.5"	-40...150	50mm	TM4811	\$268.00
	-40...150	100mm	TM4831	\$276.00
	-40...150	150mm	TM4841	\$283.00

¹⁾ PT1000 sensor element

Temperature sensors

High accuracy hygienic Temperature transmitter for CCP applications



- **CCP = Critical Control Point!**
- **Immediate LED and electronic output alarm when accuracy deviates from calibration limits**



Green = OK Blue = Pre-alert Red = Error!

For more insights:



- **Improved quality assurance in between calibration intervals**
- **Robust design for permanently precise measurements even in demanding environments**
- **Transparent sensor monitoring thanks to logging of the diagnostic values**
- **Simulation function simplifies installation**



Self-monitoring temperature transmitter type TAD
Free 5-point calibration certificate.
Diagnostic and backup function.
Scalable analogue output 4...20 mA.
T05 / T09: 3 / 6 s.
Accuracy [K]: 0.2 (at -10...130 °C).

Adjustable measuring range [°C]	Process connection	Installation depth [mm]	Factory setting -10...150 [°C]	Price
			Order no.	
Analogue output 4...20 mA				
-25...160	G 1/2 Sealing Cone	33	TCC501	\$1,034.00
		50	TCC511	\$1,037.00
		100	TCC531	\$1,044.00
		150	TCC541	\$1,052.00
	1-1.5" Tri Clamp	50	TCC811	\$1,009.00
		100	TCC831	\$1,016.00
		2" Tri Clamp	50	TCC911
	Ø 6 mm	100	TCC931	\$1,044.00
		250	TCC261	\$988.00
		350	TCC291	\$1,002.00
		450	TCC281	\$1,017.00
			550	TCC201

Accessories

Type	Description	Order no.	Price
	G1/2 - weld fitting (for Tanks)	E43300	\$63.00
	G1/2 - weld fitting (or Pipes)	E43301	\$74.00
	G1/2 - weld fitting (for deep insertion)	E30055	\$88.00
	Welding adapter for process sensors; stainless steel (1.4404 / 316L); clamping ring: PEEK; Pressure rating 10 bar; welding adapter Ø 25 mm; Approval EC1935/2004,EHEDG,FDA	E30407	\$95.00

FCM **FDA**

Hygienic Cleanable EC 1935/2004

Temperature sensors

Hygienic Temperature transmitter



Temperature transmitter with type TD display 4-digit LED display. Scalable analogue output 4...20 mA. Hygienic process connections. Installation depths of 30 to 350 mm.

T05 / T09: 1 / 3 s.

Accuracy [K]:
± 0.3 + (± 0.1 % Ms).



Factory Setting (configurable with IO-Link) [°C]	Process connection	Installation depth [mm]	Factory setting -10...150 [°C]	Price
			Order no.	
Process connection 1.5" Tri-clamp, analogue output 4...20 mA				
-50...150	Clamp 1 - 1.5"	30	TD2801	\$589.00
		50	TD2811	\$591.00
		100	TD2831	\$599.00
		150	TD2841	\$606.00
Process connection 1.5" Tri-clamp, analogue output 4...20 mA				
0...100	Clamp 1 - 1.5"	30	TD2807	\$589.00
		50	TD2817	\$591.00
		100	TD2837	\$599.00
		150	TD2847	\$606.00
Process connection G1/2, analogue output 4...20 mA				
0...100	G1/2 (BSP-P)	100	TD2531	\$625.00
		150	TD2541	\$633.00



Accessories

Type	Description	Order no.	Price
Cable, M12, 4 pole (0.34mm sensor), IP69K, 4A max			
	2.0 m, grey, MPPE cable	EVF064	\$50.00
	5.0 m, grey, MPPE cable	EVF001	\$51.00
	10.0 m, grey, MPPE cable	EVF002	\$63.00
	15.0 m, grey, MPPE cable	EVF092	\$82.00
	25.0 m, grey, MPPE cable	EVF003	\$99.00
	2.0 m, grey, MPPE cable	EVF067	\$50.00
	5.0 m, grey, MPPE cable	EVF004	\$51.00
	10.0 m, grey, MPPE cable	EVF005	\$63.00
	15.0 m, grey, MPPE cable	EVF094	\$78.00
	25.0 m, grey, MPPE cable	EVF006	\$99.00
	5.0 m, grey, MPPE cable, PNP, LED	EVF007	\$60.00
	10.0 m, grey, MPPE cable, PNP, LED	EVF008	\$72.00
	25.0 m, grey, MPPE cable, PNP, LED	EVF009	\$109.00
M12 Wirable plugs and sockets, 4-pole, IP69K, 4A max			
	M12, Wirable socket, angled	EVF566	\$56.00
	M12, Wirable socket, straight	EVF565	\$56.00
	M12, Wirable plug, angled	EVF568	\$56.00
	M12, Wirable plug, straight	EVF567	\$56.00



Accessories
Process adapters,
thermowells
Pages 127

Temperature sensors

Passive surface temperature probe



- Clamp-on solution reduces installation costs and effort
- Also suitable for use in hygienic areas
- Fast response time and high measurement accuracy for a clear process overview



External pipe diameter	Nominal width	Temperature measuring range	Measuring Accuracy	Order no.	Price
Response time T09 25 [s], protection rating IP69K					
17...21 mm	DN15	-25...160 °C	2% +/- 0.25K	TSM201	\$259.00
21...24 mm	DN20	-25...160 °C	2% +/- 0.25K	TSM301	\$259.00
25...30 mm	DN25	-25...160 °C	2% +/- 0.25K	TSM401	\$259.00
32...36 mm	DN32	-25...160 °C	2% +/- 0.25K	TSM501	\$259.00
38...45 mm	DN40	-25...160 °C	2% +/- 0.25K	TSM601	\$259.00
48...54 mm	DN50	-25...160 °C	2% +/- 0.25K	TSM701	\$259.00

Non-contact temperature sensors



- IO-Link, analogue output 4...20 mA and switching output, freely programmable
- Adjustable for different target materials
- Scratch-resistant precision lenses for minimum sensitivity to ambient light
- LED pilot light for alignment and control
- Simulation function: activated on the sensor or by external control signal



Temperature sensor accessories



No.	Type	Device connection	Process connection	Order no.	For sensor type				Price
Industrial applications									
1	Progressive ring fitting	Ø 6 mm	G 1/2	E30047	TA	TD	TCC	TT	\$65.00
1	Progressive ring fitting	Ø 10 mm	G 1/2	E30016				TT	\$63.00



No.	Device connection	Process connection	Installation depth [mm]	Order no.	For sensor type				Price
Hygienic applications									
2	Clamp adapter	Ø 6 mm	G 1/2 with sealing cone	E30144	TA	TD		TT	\$114.30



Industrial applications									
3	G 1/2	G 1/2	27	E37600	TA241x	TN2415	TM4411	TT0281 ¹⁾	\$110.00
			74	E37610	TA243x	TN2435	TM4431	TT1281 ¹⁾	\$117.00
			82	E35010				TT1081 ⁴⁾	\$129.00
			124	E37620	TA244x	TN2445	TM4441	TT2281 ¹⁾	\$124.00
			174	E37630				TT2281 ¹⁾	\$131.00
			182	E35020				TT2081 ⁴⁾	\$144.00
			224	E37640			TM4461	TT3281 ¹⁾	\$139.00
			282	E35030				TT3081 ⁴⁾	\$159.00
482	E35050				TT5081 ⁴⁾	\$188.00			



No.	Device connection	Installation depth [mm]	Order no.	For sensor type				Price
Hygienic applications								
4	G 1/2 with sealing cone	68	E37511	TA253x	TD253x	TM4531	TT1291 ²⁾	\$164.00
		118	E37521	TA2542	TD254x	TM4541	TT2291 ²⁾	\$172.00
5	G 1/2 with sealing cone	49	E37411	TA2512	TD251x	TM4511	TT0291 ²⁾	\$175.00
		99	E37421	TA253x	TD253x	TM4531	TT1291 ²⁾	\$183.00
		149	E37431	TA2542	TD254x	TM4541	TT2291 ²⁾	\$191.00



No.	Type	Device connection	Process connection	Order no.	For sensor type		Price
6	Stainless steel adapter	M18 x 1.5	G 1/2	E30073	TM	TN	\$100.00
	Titanium adapter	M18 x 1.5	G 1/2	E40114	TM	TN	\$292.00



Humidity sensors

Air Humidity sensor



- Simple monitoring of temperature and air humidity to protect electrical installations, control cabinets or production processes
- Plug & Play thanks to screw or rail mounting and M12 connection
- Data output per analogue signal



Protection of control cabinets and servers.

Electrical switch gear should be protected against humid air! This also applies to control cabinets in automated production plants. Not least, in hygienic conditions, experienced in the food industry. Humidity can enter the control cabinet due to the frequent cleaning processes. Via fittings, air slits, defective sealings, or simply doors that have not been closed properly... If the humidity inside remains undetected, corrosion will follow. A simple humidity sensor can keep your assets protected, 24/7!



Temp Range [°C]	Output	IP rating	Order no.	Price
Humidity measuring sensor				
-40...60	2 x 4...20 mA	IP 20, III	LDH290	\$392.00
-40...80	IO-Link	IP 20, III	LDH292	\$381.00

Oil Humidity sensor (capacitive principle)



Connection	Temp Range [°C]	Output	IP rating	Order no.	Price
Humidity measuring sensor, M12, 8 pole connector (refer page 133)					
G 3/4	-40...105	2 x 4...20 mA	IP 67	LDH100	\$1,420.00
G 1/2	-40...120	2 x 4...20 mA	IP 68	LDH110	\$1,116.00
G 1/2	-40...120	IO-Link	IP 68	LDH112	\$1,085.00

Pressure dew point sensor - WATCH THIS SPACE!



Connection	Dew point temp range	Output	IP rating	Order no.	Price
G 1/2	-20...20 Ctd	IO-Link, 4...20 mA	IP69k	LDH313	POA
G 1/2	-60...20 Ctd	IO-Link, 4...20 mA	IP69k	LDH314	POA

Type	Description	Order no.	Price
	Unscrewable filler cap	E33709	POA
	Fast coupling adaptor	E33710	POA

Oil condition sensors

Oil Particle monitor



- Trend monitoring by analysis of the particle concentration
- Indication of purity class on the LCD display
- Applications up to 420 bar
- Intuitive, user-friendly handling
- CAN bus, analogue and switching outputs



The LDP is designed as a hydraulic system component.

This device is an optical particle monitor designed to assess the purity of hydraulic oils. It operates on the principle of light extinction, which measures the attenuation of light caused by particles suspended in the fluid.

The detected particle levels are then converted into standardised cleanliness classes, which are displayed on the device. Multiple interfaces are available to read and transmit the measured data.

Medium Temp	Medium Pressure	Process connection	Outputs	Accuracy	Order no.	Price
Media: mineral oils (e.g. HLP); ester oils (e.g. HEES); biodegradable oils (e.g. HETG),						
-10...80°C	< 420 bar	Threaded connection M16 x 2 external thread Minimess	1 x 4...20 mA 1 x digital	+/- 1%	LDP100	\$4,968.00

Oil viscosity sensor



Medium Temp [C]	Measuring range	Process connection	Outputs	Accuracy	Order no.	Price
Oil viscosity sensor						
-40...125	0...200 cSt (mm²/s)	G3/8 (BSP)	2 x 4...20 mA 1 x digital CANopen	+/- 5% (+/- 1% cSt)	ZJF168	\$2,202.00

Accessories

Type	Description	Order no.	Price
	M12, 2 m, 8 pole, black, PUR cable	E11231	\$82.00
	M12, 5 m, 8 pole, black, PUR cable	E11232	\$102.00
	M12, 10 m, 8 pole, black, PUR cable	E12260	\$114.00

Conductivity sensors & mounting accessories



Learn more



- Reduce inaccuracies associated with a time-based cleaning process
- Improve process performance with flexible measurement points
- Compact, high-quality sensor design prevents failures and unplanned downtime
- 🔗 Simplify your installation and commissioning processes
- 🔗 Loss-free signal transmission of measurement values
- Accuracy conductivity 2 % MW ± 25 µS/cm



Process connection	Measurement range conductivity [µS/cm]	Measurement range [°C] medium temperature	Accuracy conductivity	Article no.	Price
Application: Media differentiation between product /rinsing water / cleaning agent					
G 1/2	100...15,000	-25...100; (< 1 h: 150)	10 % MW ± 25 µS/cm	LDL100 🔄	\$1,387.00
Application: Media ultra pure water					
G 1/2	0.04...1,000	-25...100; (< 1 h: 150)	10 % MW ± 25 µS/cm	LDL101 🔄	\$1,882.00

Type	Process connection	Order no.	Price
	G 1/2 I – G 3/4 A adaptor	E43302	\$87.00
	G 1/2 I – G 1 A adaptor	E43303	\$158.00
	G 1/2 into 1-1.5" Tri clamp adaptor with leakage port	E43311	\$150.00
	G 1/2 into 2" Tri clamp adaptor with leakage port	E43312	\$207.00
	G 1/2 into 1-1.5" Tri clamp adaptor	E33401	\$117.00
	G 1/2 into 2" Tri clamp adaptor	E33402	\$117.00

High accuracy conductivity sensors



FCM FDA Hygienic Cleanable EC:1935/2004



Image	Process connection	Measurement range conductivity [$\mu\text{S}/\text{cm}$]	Measurement range [$^{\circ}\text{C}$] medium temperature	Article no.	Price
Application: Media differentiation between product /rinsing water / cleaning agent					
	G 1 thread Aseptoflex Vario	100...1,000,000	-25...100; (< 1 h: 150)	LDL200	\$2,795.00
Inductive conductivity measurement like LDL200 with extended probe length for tri clamp					
	G 1	100...1,000,000	-25...100; (< 1 h: 150)	LDL201	\$2,948.00
	G 1 thread sealing cone*	100...1,000,000	-25...100; (< 1 h: 150)	LDL210	\$2,795.00
	G 1/2	100...1,000,000	-25...100; (< 1 h: 150)	LDL220	\$2,857.00
	G 1.5	100...2,000,000	-25...100	LDL400	\$1,473.00

* Attention: The unit must only be installed in a process connection for G1 sealing cone. The G1A sealing cone of the unit is only suited for adapters with metal end stop.

Accessories

Type	Description	Order no.	Price
	Tri-clamp – G 1 Aseptoflex Vario 1.5" with leakage port	E33208	\$135.00
	Tri-clamp – G 1 Aseptoflex Vario 2" with leakage port	E33209	\$155.00
	D50 – G 1 external thread Aseptoflex Vario with leakage port	E30130	\$129.00
	D38 – G 1 external thread Aseptoflex Vario with leakage port	E30500	\$129.00

Selection guide: overview of conductivity sensors and their measuring ranges

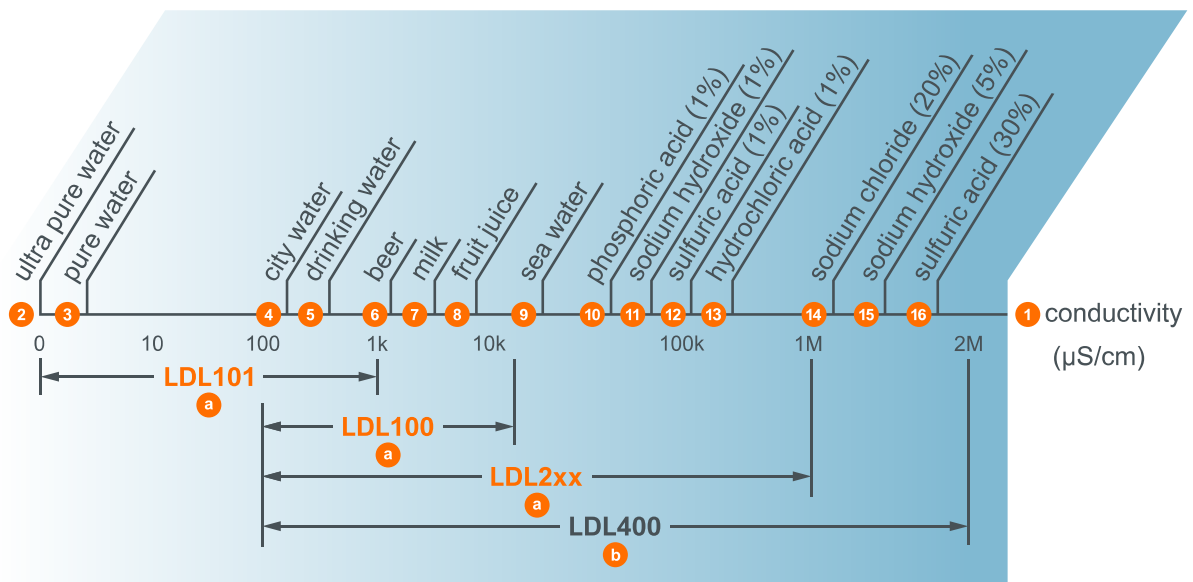

Plant condition monitoring solutions



Learn more

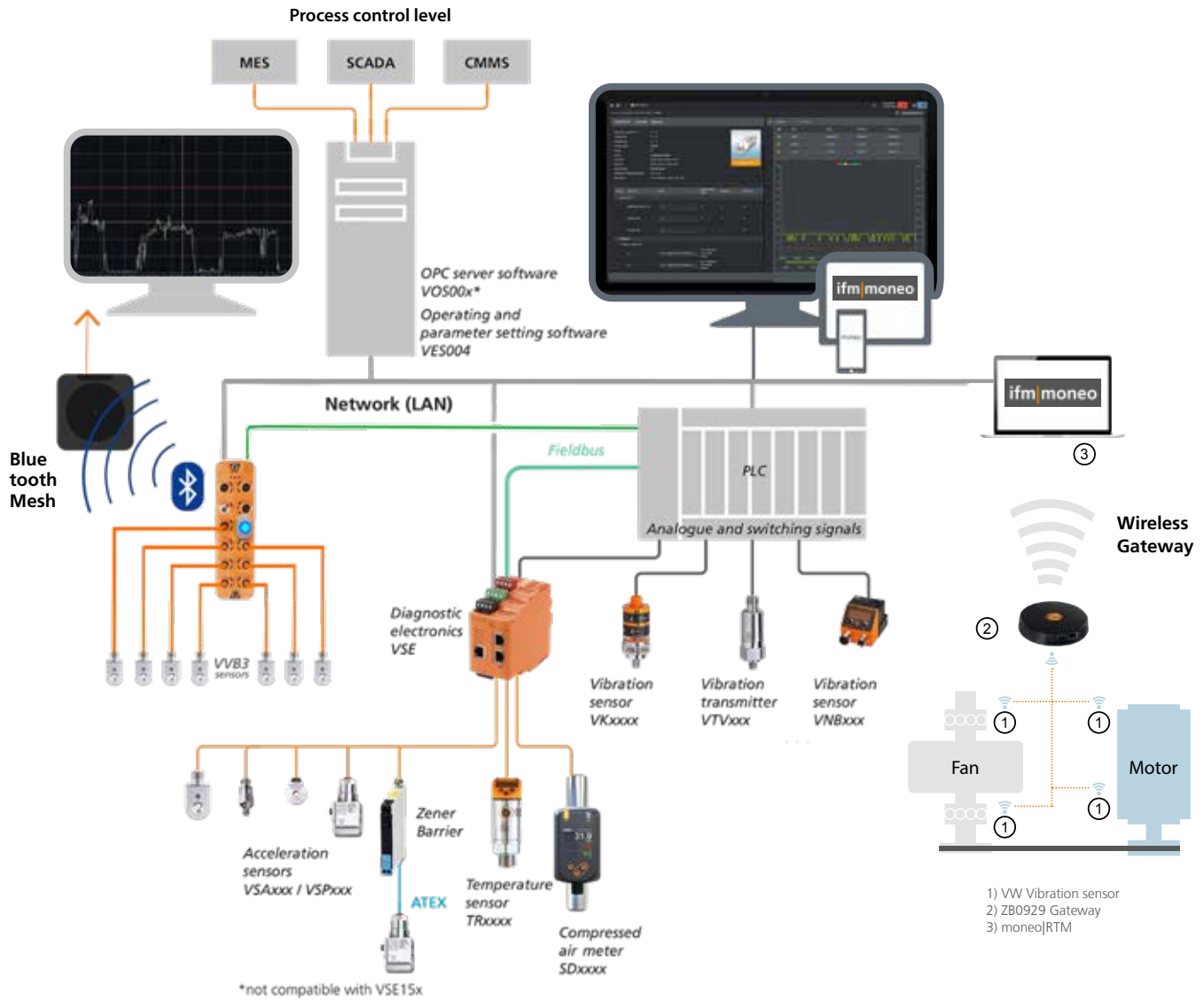

Vibration sensors on the drives detect even smallest vibrations.



The VSE100 evaluation unit evaluates the signals from up to four vibration sensors.

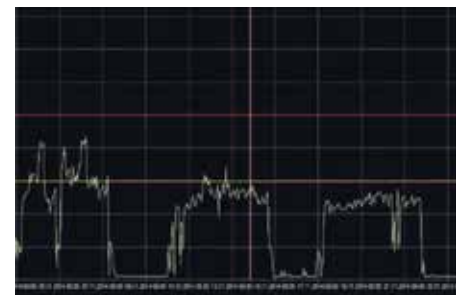

Vibration characteristics can be visualised via PC in a control room. Operators can set limits (yellow and red lines for pre-alarm and main alarm).

Vibration causes:



Looseness, unbalance

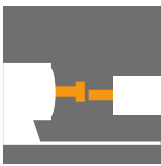

Misalignment



Rolling element bearing



Gearbox Meshing, tooth fault



Pump Eccentricity, cavitation

Imagine:

- If your production equipment was always available as planned?
- If your cycle time was never compromised due to a damaged machine?
- If your production equipment self-detected and alerted you of quality defects?

Applying Real-time Maintenance (RtM) technologies to your production equipment increases equipment availability, maintains machine throughput, and minimises material losses.

Common industrial maintenance strategies

There are 3 basic types of industrial maintenance processes and each have costs associated with them.

- Reactive maintenance -- highest total cost of ownership. Run-to-failure strategy and unplanned downtime is usually more expensive than planned downtime and typically there is secondary damage to other components.
- Preventative maintenance -- downtime is scheduled prior to failure. Carries a high cost because parts and labour are consumed prematurely.
- Predictive or Condition-based maintenance -- uses RtM technology to optimise equipment use. Maintenance is performed only when necessary without production loss.

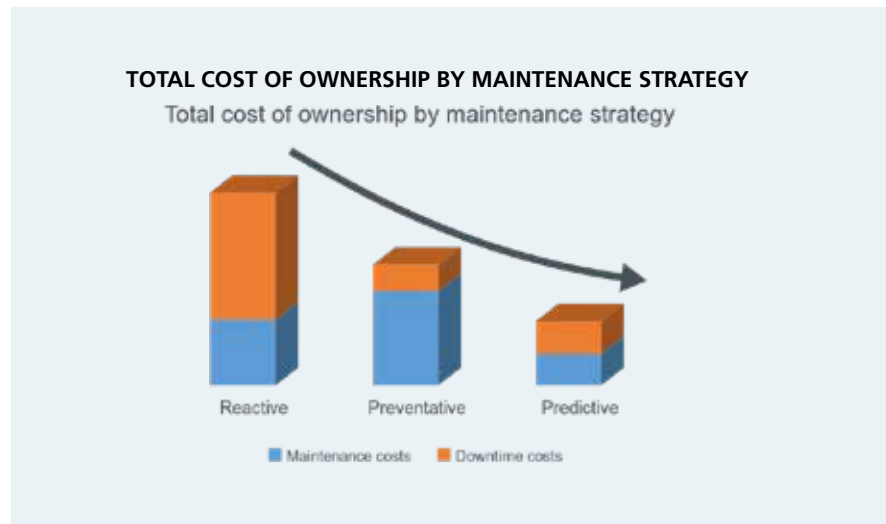

RTM technologies for predictive maintenance

Advances in technologies for industrial networks, reduction in size and cost of computational power, and advances in smart sensors are making predictive systems a reality. These innovations are changing the way companies manage their equipment maintenance.

Operational worthiness in real time is key to improving OEE (Overall Equipment Effectiveness) and increasing profits. Implementing RtM is at the core of any Industry 4.0 initiative. With ifm RtM products, machines can communicate their operational status in real time, automatically plan maintenance, reduce downtime, and improve quality – all improving your bottom line.

Plant Condition Monitoring Innovations



Taking complexity out of simple machine monitoring

Turn your real time data into actionable insights

- Machine health - continuous transparency of machine reliability.
- With the new VVB and the IIoT platform moneo, maintenance is easier than ever before.

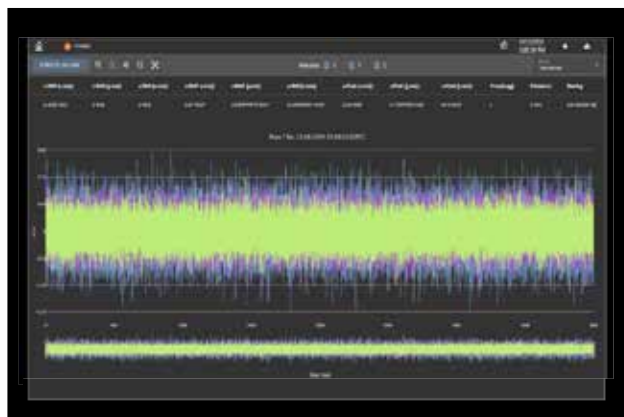

moneo Analytics

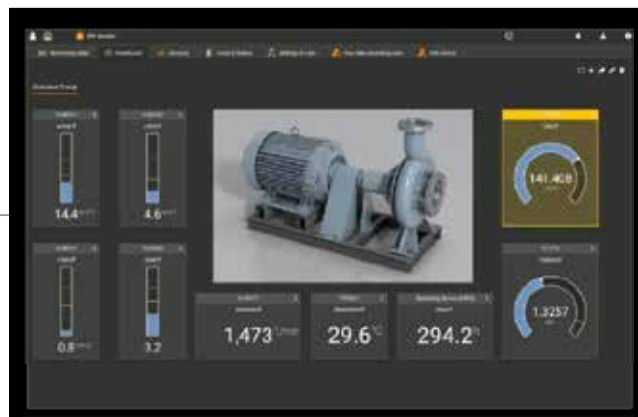

moneo: Your maintenance co-pilot

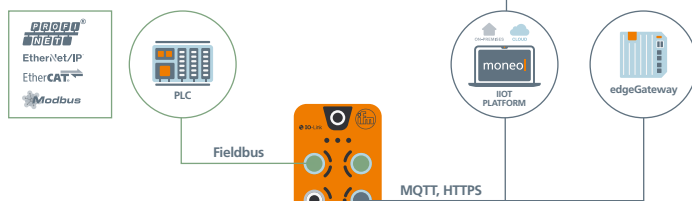

- Trend values**
- Fatigue | v-RMS – xyz
 - Impact | a-Peak – xyz
 - Friction | a-RMS – xyz
 - Crest – xyz*
 - Surface temperature

- Advanced analysis features**
- Unbalance Detector
 - BearingScout™**
 - Raw waveform
 - Machine operation time
 - Trend history

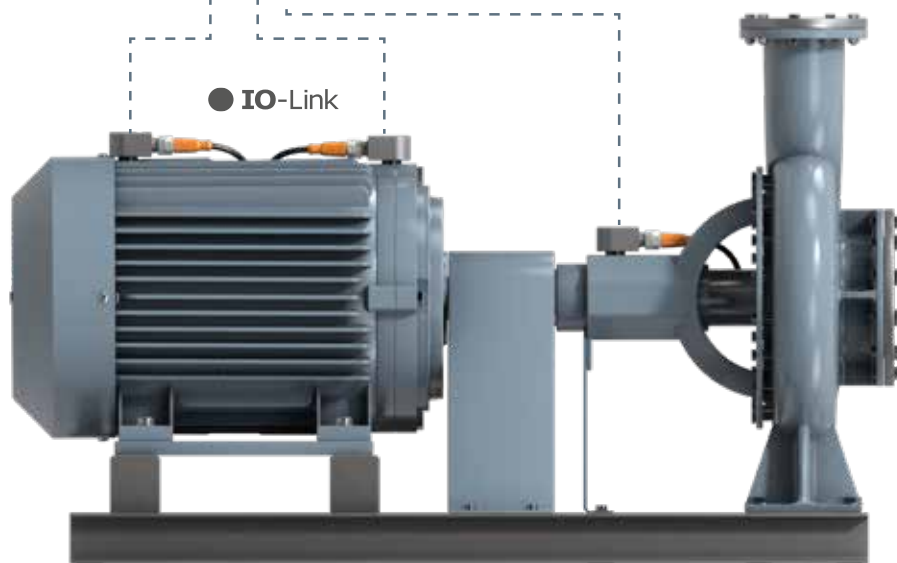

Plant condition monitoring

Industrial - IO-Link systems for continuous vibration monitoring and diagnostics



North Otago Irrigation pump station, employs ifm IO-Link condition monitoring systems. This state of the art pump station transfers 2 m³/s

VVB3 monitors 3 dimensions, value setting to ISO 20816-3	Order no.	Price
Basic vibration sensor; PNP/NPN; (configurable); NO / NC; (parameterisable); Measuring range of vibration 0...45 mm/s; Frequency range 2...5,600 Hz; Protection to IP69K; M12 Connector	VVB305	\$769.00
DataScience vibration sensor; PNP/NPN; (configurable); NO / NC; (parameterisable); Measuring range of vibration 0...45 mm/s; Frequency range 2...5,600 Hz; Protection to IP69K; M12 Connector	VVB306	\$849.00

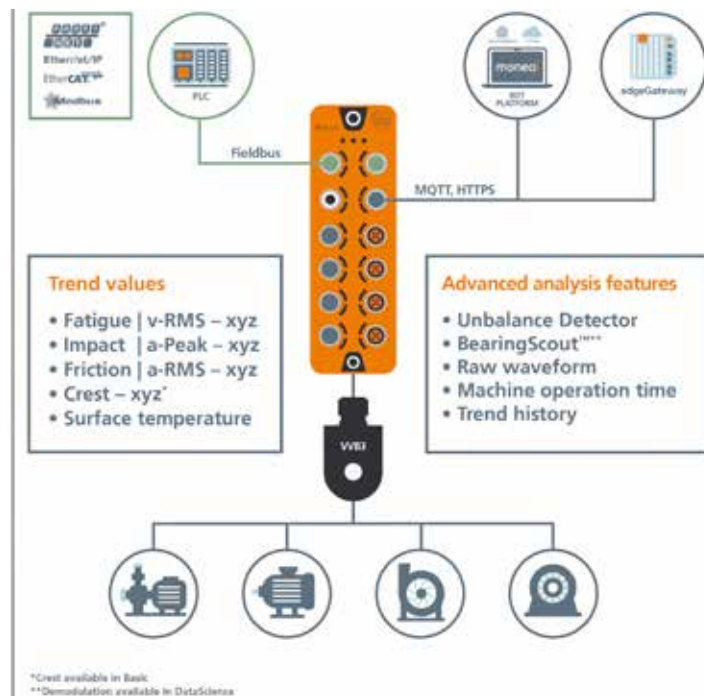

Mobile machines - IO-Link systems for continuous vibration monitoring and diagnostics





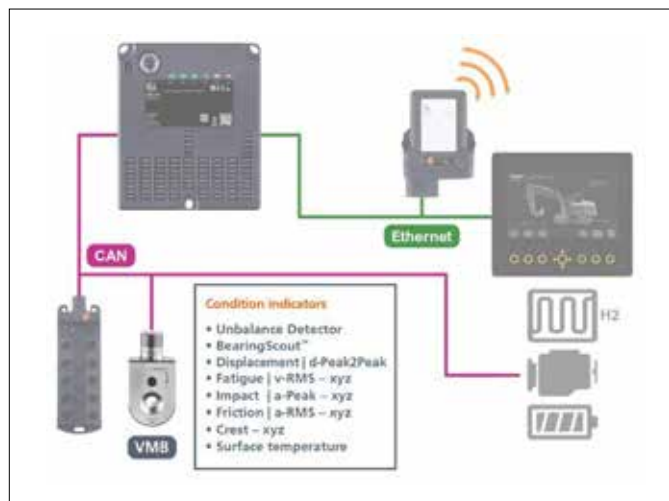







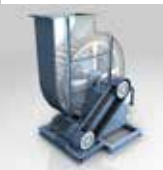

Description	Order no.	Price
3 axis vibration sensor with CANopen interface, frequency range [Hz] 1...7500, measuring range, displacement 0...320mm, IP69k protection rating	VMB301	\$791.00



Plant condition monitoring: selection chart

From simple to complex monitoring



Machine classification	Application		Single-point measurement	IO-Link	Multi-point measurement	Prog. diagnostic electronics
			VN	VV	VSA / VSP	VSE
						
			<p>Intelligent vibration sensors type VN On board display, history storage for documentation, for rotating machines >120 rpm.</p>	<p>Intelligent vibration sensors type VV Detection of numerous vibration parameters with optional raw data acquisition (BLOB) for extended analyses as well as integrated machine uptime detection based on the vibration values.</p>	<p>Acceleration sensors type VSA / VSP / VSM Different types, also for mounting in difficult to access areas. Various measuring ranges with voltage output (100 mV/g) or current loop (0...10 mA). Connection to the VSE diagnostic electronics.</p>	<p>Diagnostic electronics type VSE 4-channel diagnostic module with additional process value inputs, integrated history memory and networking possible.</p>
<p>Type 1 - simple machines</p> <ul style="list-style-type: none"> • Single-shaft machines • Predominantly constant speed • Low process and design-related forces 	<ul style="list-style-type: none"> • Electric motors • Gear motors • Fans • Centrifugal pumps • Reduction gears • Separators • HVACs • Conveyor belts • Vacuum pumps 					
<p>Type 2 - process machines</p> <ul style="list-style-type: none"> • Different processes (load/no load operation) • High process forces • Variable use (higher load / speed) 	<p>High process forces</p> <ul style="list-style-type: none"> • Decanter centrifuges • Centrifugal compressors • Industrial mixers • Homogenisers • Crane applications • Extruders 					
	<p>Very high process forces *</p> <ul style="list-style-type: none"> • Machine tools • Crushers • Milling machines • Storage and retrieval systems • Sorting machines • Vibrating conveyors • Sawing machines • Hydraulic presses • Filling systems / Bottling lines 					
<p>Type 3 - complex machines</p> <ul style="list-style-type: none"> • Multiple shafts and complex kinematics • High design-related forces 	<p>Reciprocating compressors</p> <ul style="list-style-type: none"> • Screw-type compressors • Multi-stage gearboxes • Combustion engines • Turbines 					

* Use VVB only for process force monitoring



Waste water treatment plant Kressbronn, Germany

At the waste water treatment plant Kressbronn, numerous pumps with various characteristics are used to convey liquid media through the various areas of the waste water treatment plant. Unplanned downtime can have severe repercussions, potentially disrupting the entire municipal waste water disposal system or even causing a complete halt to its operations.

In the case of liquid pumps, bubbles can form if the pressure difference between the inlet and outlet side is too high: resulting in cavitation. The tiny bubbles filled with vapour collapse suddenly due to the high pressure. This sudden collapse creates shock waves that repeatedly erode the pump element and the pump housing from the inside. If the damage becomes too great, the pump can no longer work properly. In the worst case, expensive repairs or even the replacement of the pump may become necessary.

moneo | RTM

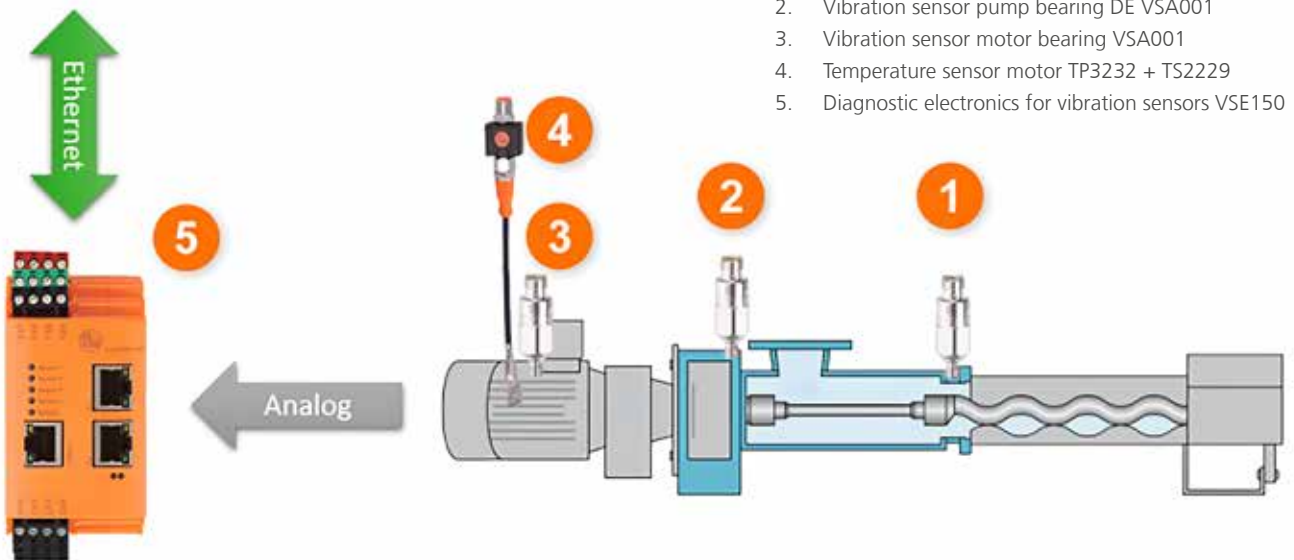

1. Vibration sensor pump bearing NDE VSA001
2. Vibration sensor pump bearing DE VSA001
3. Vibration sensor motor bearing VSA001
4. Temperature sensor motor TP3232 + TS2229
5. Diagnostic electronics for vibration sensors VSE150

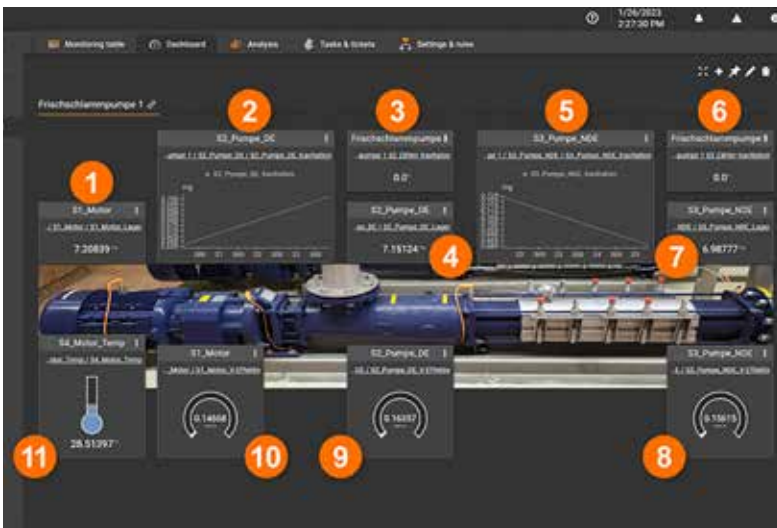

1. Vibration motor bearing [mg]
2. Cavitation recognition pump DE [mg]
3. Time counter cavitation DE [h]
4. Vibration pump bearing DE [mg]
5. Cavitation recognition pump NDE
6. Time counter cavitation NDE [h]
7. Vibration pump bearing NDE [mg]
8. V-effective pump bearing NDE [mm/s]
9. V-effective pump bearing DE [mm/s]
10. V-effective motor bearing [mm/s]
11. Motor temperature [C°]

Plant condition monitoring

Systems for continuous vibration monitoring and diagnostics

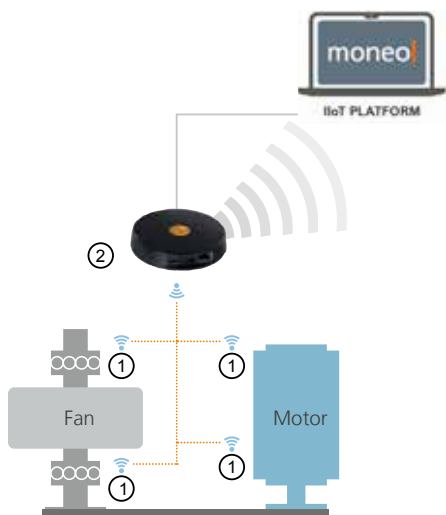

1) VW Vibration sensor
2) ZB0929 Gateway
3) moneo|RTM

Type	Description	Article no.	Price
	Ethernet/IP, diagnostic electronics for vibration accelerometers as shown below, Input/ Output Total: 8 (parameterisable)	VSE163	POA
	Profinet IO Device Class C	VSE150	\$2,832.00
	Modbus TCP	VSE153	\$2,832.00
	Ethernet, diagnostic electronics for vibration accelerometers as shown below, Input/ Output Total: 8 (parameterisable)	VSE003	\$1,469.00

Accelerometer

Type	Description	Article no.	Price
	Vibration Sensor, IP68/69K, 0 to 10mA output	VSA001	\$468.00
	Acceleration sensor; Measuring range of vibration -50...50 g; Frequency range 2...10000 Hz; Ambient temperature -55...125 °C; IP 67; Connector	VSP001	\$641.00
	Vibration sensor: Large operating temperature range and high protection rating for the requirements of harsh industrial environments	VSP003	\$764.00
	Vibration sensor submersible: Large operating temperature range and high protection rating for the requirements of harsh industrial environments	VSP004	\$1,230.00
	3 measurement axis. Acceleration sensor; Measuring range of vibration -40...40 g; Frequency range 0...4500 Hz; Ambient temperature -30...85 °C; IP 69K; cable	VSM101	\$1,191.00
	Measuring range of vibration [g] -16...16	1 Axis VVV001	\$624.00
	Measuring range of vibration [mm/s] 0...25 Frequency range [Hz] 10...1000	3 Axis VVV002	\$583.00
	Wireless vibration sensors gateway	ZB0929	\$1,105.00
	2 switching outputs, or 1 switching output and 1 4...20 mA (set via pushbuttons), 1 input 4...20 mA (VNA001)	VNB001	\$1,057.00

Accessories

Type	Description	Article no.	Price
	Mounting Accessory (for electrical isolation)	E30132	\$56.00

Vibration transmitter and switch



Description	Article no.	Price
Vibration transmitter; analogue; Total number of inputs and outputs 1; Measuring range of vibration 0...25; (RMS) mm/s; Frequency range 10...1000 Hz; Ambient temperature -30...125 °C; IP 67; IP 68; IP 69K; Connector	VTV122	\$555.00
Vibration transmitter to ISO 10816, measuring range RMS: 0...25 mm/s, analogue output 4...20 mA, 24VDC, M12 connector + switching output.	VKV021	\$474.00
Vibration transmitter to ISO 10816, measuring range RMS: 0...50 mm/s, analogue output 4...20 mA, 24VDC, M12 connector + switching output.	VKV022	\$474.00

RFID systems with IO-Link



Learn more

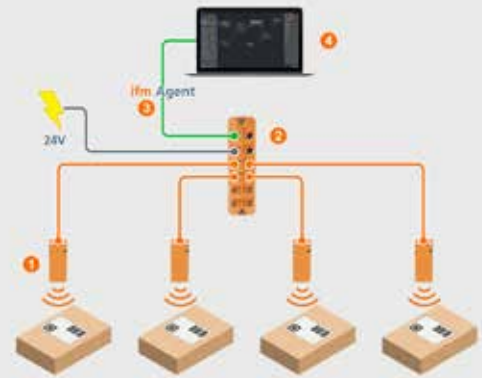

The ID tag chip is installed at the base of the workpiece carrier. The chip can store up to 224 bits.

Type	Description	Part No	Price
RFID Evaluation Units			
	RFID evaluation unit, EtherNet/IP interface	DTE102	\$1,510.00
	RFID evaluation unit, EtherCAT interface	DTE103	\$1,431.00
IO-Link RFID Antennas			
	Read/write head; 13,56 MHz; IO-Link; 40 x 40 x 54 mm; Ambient temperature -20...60 °C; IP 67; IP 69K	DTI513	\$506.00
	Read/write head; 13,56 MHz; IO-Link; 20 x 7 x 48 mm; Ambient temperature -20...60 °C; IP 67; IP 69K	DTI515	\$440.00
RFID Antennas			
	RFID antenna 13.56 MHz, M30 design, flush	ANT430	\$540.00
	RFID antenna 13.56 MHz, M30 design, non-flush	ANT431	\$540.00
	RFID antenna 125 KHz	ANT512	\$542.00
	RFID antenna 13.56 MHz, ISO 15693	ANT513	\$572.00
Accessories			
	ID tag; 13,56 MHz; Ø 50 / L = 3 mm; Ambient temperature -25...85 °C; IP 68; IP 69K	E80383	\$62.00

Mobile machine automation solutions



Learn more



Always the first choice. Robust, flexible, reliable.

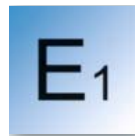

Construction machines



Agriculture and forestry



Transport and logistics



Municipal vehicles

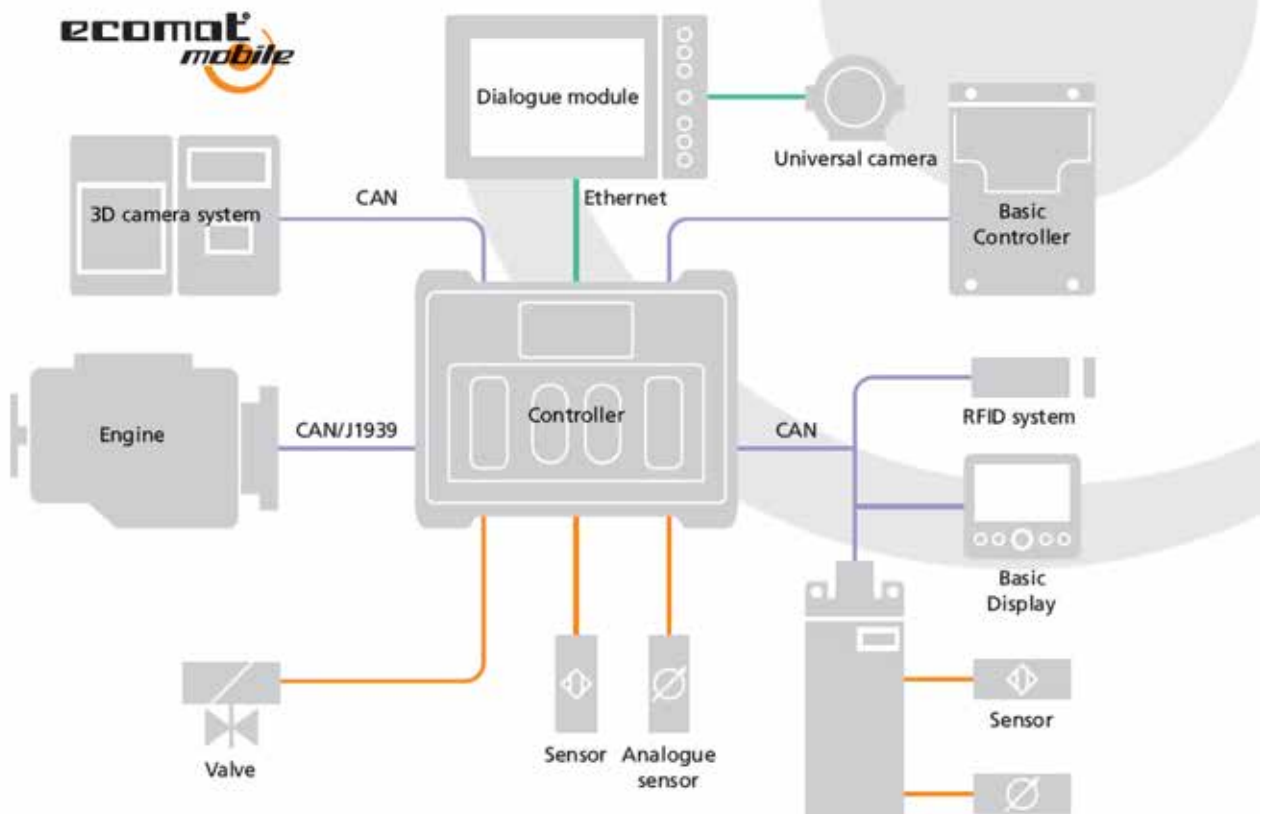



Powerful dialogue modules for mobile machines housing optimised for mobile machines



LED displays with optical bonding	Order No.				
	CR1152	CR1077	CR1102	CR1204	CR1203
Display	5.0"	7.0"	10.0"	12.0"	12.3"
Prices	\$3,061.00	\$4,844.00	\$5,304.00	\$6,082.00	\$6,089.00
Aspect ratio	16:10	16:10	16:10	16:10	8:3
Resolution	800 x 480	800 x 480	1280 x 800	1280 x 800	1280 x 480
Colour depth	24 bit	18 bit	24 bit	24 bit	24 bit
Touch	•	•	•	•	•
Controller with GPU	dual core, 800 Mhz	quad core, 1.2 GHz	ARM Quad Core 64 Bit, 1.2 GHz	ARM Quad Core 64 Bit, 1.2 GHz	quad core, 1.2 GHz
Memory (RAM) [GByte]	1	1	1	1	1
Memory (flash) [GByte]	4	8	8	8	8
Buttons (RGB backlit)	4	6	8	10	-
Navigation element	cross	cross	cross	cross	-
COMMUNICATION INTERFACE	1	2	2	2	2
Ethernet	4	4	4	4	4
CAN	1	2	2	2	2
Analogue video interfaces	2	4	4	4	4
AUDIO INTERFACES					
Stereo Out (amplified)	1	1	1	1	1
Line In	-	1	1	1	1
Headphones Out	-	1	1	1	1
INPUTS / OUTPUTS					
Digital In BL	2	2	2	2	2
Digital Out 2.5 A	2	2	2	2	2

4.3" Basic display - with added features



Display size	Input functions	Operating elements	Interfaces	Order no.	Price
4.3" colour display	1 x digital input	6 prog. backlit function keys 1 x navigation key with push button	1 x CAN, 1 x EtherNet	CR1140	\$1,317.00
4.3" colour display	1 x digital input	6 prog. backlit function keys 1 x navigation key with push button	1 x CAN, 1 x USB	CR1141	\$1,317.00
4.3" colour display	1 x digital input	Touch screen	1 x CAN, 1 x EtherNet	CR1142	\$1,312.00
4.3" colour display	1 x digital input	Touch screen	1 x CAN, 1 x USB	CR1143	\$1,312.00
4.3" colour display	1 x digital input	Display screen only	1 x CAN, 1 x EtherNet	CR1144	\$1,091.00



ecomatController



Safety				
I/O total	Inputs	Outputs	Order No.	Price
60	32x Digital, 16x Analogue 8x Frequency, 4x Resistance	27x Digital, 1x Analogue 3x PWM 4.0A, 9x PWM 2.5A, 3x H-Bridge	CR711S	\$2,855.00
98	60x Digital, 24x Analogue 16x Frequency, 4x Resistance	36x Digital, 2x Analogue 4x PWM 4.0A, 12x PWM 2.5A, 4x H-Bridge	CR720S	\$3,826.00
124	68x Digital, 24x Analogue 16x Frequency, 4x Resistance	54x Digital, 1x Analogue 6x PWM 4.0A, 18x PWM 2.5A, 6x H-Bridge	CR721S	\$4,927.00

WATCH THIS SPACE!

	Inputs	Outputs	Order No.	Price
			CR7078	POA
			CR7079	POA



BASIC CAN bus controllers, IP20



I/O total	Input functions	Output functions	Interfaces	Order no.	Price
20	12 x digital, 4 x analogue (U/I) 4 x frequency, 4 x resistance	8 x digital, 8 x PWM	2 x CAN	CR0401	\$489.00
24	12 x digital, 4 x analogue (U/I) 4 x frequency, 4 x resistance	12 x digital, 2 x PWM-I 10 x PWM	2 x CAN	CR0403	\$652.00
16	8 x digital, 4 x analogue (U/I) 4 x frequency, 4 x resistance	8 x digital, 8 x PWM-I 8 x PWM, 4 x H bridge	2 x CAN	CR0411	\$675.00
14	8 x digital, 4 x analogue (U/I) 4 x frequency, 4 x resistance	6 x relay	2 x CAN	CR0431	\$682.00
24	12 x digital, 8 x analogue (U/I) 4 x frequency, 4 x resistance	12 x digital, 12 x PWM, 2 x PWM-I	2 x CAN	CR403S	\$691.00
32	16 x digital, 12 x analogue (U/I) 4 x frequency, 4 x resistance	16 x digital, 12 x PWM, 4 x PWM-I	2 x CAN	CR413S	\$1,131.00



Relay modules, IP20

Locations	Order no.	Price
6 automotive relays, 10 automotive fuses	CR0421	\$80.00



I/O module for mobile machines

Inputs	Outputs	Description	Order no.	Price
3x analogue (12 bits)	1x H-bridge, PWM	High current CANopen relay for mobile machines, 10 A	CR3025	\$209.00



Dialogue modules, IP65/67

Display size	Operating elements	Interfaces	Order no.	Price
2.8" colour display	5 freely programmable backlit function keys, cursor key	1 x CAN	CR0451	\$802.00
4.3" colour display	6 freely programmable backlit function keys, cursor key	1 x CAN	CR0452	\$1,148.00

Controller starter set for mobile machines



Description	Order No.	Price
ecomatController/Starterkit	EC2121	\$1,759.00



FIELD CAN bus modules, IP67



I/O Total	CompactModule, IP 67					Order no.	Price
16	-	16x Digital, 16x PWM, 8x PWM-I	DEUTSCH	2 x CAN	CR2051	\$924.00	
16	8x Digital, 4x Analogue	8x Digital, 8x PWM, 8x PWM-I	Connector	2 x CAN	CR2052	\$902.00	
8	-	16x Digital, 16x PWM, 8x PWM-I	M12	2 x CAN	CR2041	\$868.00	
16	16x Digital, 4x Analogue	8x Digital, 8x PWM, 8x PWM-I	M12	2 x CAN	CR2042	\$847.00	
16	16x Digital, 8x Analogue	-	M12	2 x CAN	CR2040	\$720.00	

BASIC CAN bus controllers, IP67



I/O total	Input functions	Output functions	Interfaces	Order no.	Price
SmartController, IP 67					
32	16 x digital, 4 x analogue (U/I) 4 x frequency, 2 x resistance	16 x digital, 2 x PWM-I 12 x PWM, 2 x analogue 0.2...10 V	2 x CAN	CR2530	\$1,205.00
64	32 x digital, 8 x analogue (U/I) 8 x frequency, 4 x resistance	32 x digital, 4 x PWM-I 24 x PWM, 4 x analogue 0.2...10 V	3 x CAN	CR2532	\$2,116.00

Accessories

Type	Description	Order no.	Price
	Wireable AMP connector	EC2013	\$83.00

Radar distance sensor for harsh environments <30m range



Description	Aperture Angle H x V [°]	Frequency [GHz]	Outputs (2x configurable)	Order no	Price
Distance sensor, narrow adjustable angle True ground speed feature	H40 x V20	77...81	CAN (SAE J1939)	R1D201	\$1,521.00
Distance sensor, wide adjustable angle	H140 x V30	77...81	CAN (SAE J1939)	R2D201	\$1,874.00

Accessories

Description	Order no.	Price
	E23009	\$90.00
	E23010	\$86.00
	E23011	\$71.00

Radar range sensor

Radar 3D Area

- Adjustable detection field
- Filtered object detection
- Output of position data and target object speed
- 8 freely definable warning zones, 2 configurable masking zones
- Output of the direction of movement and adjustable early warning time
- Intelligent algorithm that can distinguish between moving and static targets, even if the sensor is also moving



Radar distance sensor

R1D Distance

- Focussed radar beam allowing the detection of objects at a distance of up to 50 m
- Output of range profiles and visualisation of all targets in the detection range with the ifm Vision Assistant
- Simultaneous, non-contact detection of an object's distance, speed and direction of movement
- Output of inclination values to allow sensor orientation monitoring in 2 directions, IO-Link diagnostics and monitoring function





Automatic collision avoidance: 3D camera at the rear automatically warns of obstacles and possible collisions.

CAN bus devices



Type of sensor	Image resolution	Angle of aperture [°]	Order no.	Price
O3M 3D smart sensor, CAN interface				
Mobile	1280 x 960	143 x 112	O3M372	\$4,298.00
O3M illumination unit - for the operation of O3M250 / O3M251				
infrared light 850 nm	–	97 x 44	O3M970	\$1,812.00

CAN bus Absolute multi-turn ENCODERS



Absolute multiturn encoder	Order no.	Price
Resolution = 4096 steps; 4096 revolutions; 24 bit, Communication interface = CAN, Solid shaft = 10mm dia.	RM9000	\$704.00

CAN bus Safety Absolute ENCODERS



Housing Ø [mm]	Shaft Ø [mm]	Design shaft	Flange	Order no.	Price
58	10	Solid shaft	Direct dia. 58mm	RM9005	\$1,731.00
58	12	Hollow shaft	Direct dia. 63mm	RM9015	\$1,769.00
58	10	Solid shaft	Direct dia. 58mm	RM9025	\$1,866.00
58	12	Hollow shaft	Direct dia. 63mm	RM9035	\$1,904.00

RFID system sensors 13.56 MHz



Design	Range referred to Ø 30 mm ID Tag	Order no.	Price	
DTM evaluation unit / antenna, CAN interface				
M18, nf	40	DTM425	\$526.00	
40x40 x54mm	≤ 60, nf	DTC510	\$598.00	
Description			Order no.	Price
ID TAGs (selection) for 13.56 MHz system				
ID tag; 0,125 MHz; Ø 30 / L = 2.5 mm; Temp -25...85 °C; memory 192 bits			E80360	\$22.00
ID tag; 0,125 MHz; Ø 30 / L = 2.5 mm; Temp -25...85 °C; memory 1984 bits			E80361	\$35.00
Ø 30 x 2.8mm / 5.2mm mounting hole size - 896 bits			E80371	\$28.00



Mobile machines sensors



Description	Order no.	Price
2 axis		
2x Axis. Angular range $\pm 180^\circ$. Output 1, IO-Link NO/NC prog. Output 2 - NO/NC prog. PNP/NPN. Analogue 4...20 mA. Output 3 and 4 analogue, 4...20M & 2...10V	JN2200	\$773.00
2x Axis. Angular range $\pm 45^\circ / 90^\circ$, IO-Link. Output 1 - IO-Link NO/NC prog. Output 2 - NO/NC prog. PNP/NPN. Analogue 4...20 mA & 2...10V	JN2201	\$859.00
1 or 2 axis		
Inclination sensor; 27 x 59 x 118.5 mm; CAN; Ambient temperature -40...85 °C; M12 Connector; [inclination measurement]: $\pm 90^\circ$	JD2120	\$1,438.00
Inclination sensor; 27 x 59 x 105.3 mm; CAN; Ambient temperature -40...85 °C; M12 Connector; [inclination measurement]: 0...360 °	JD1111	\$1,392.00

Inductive sensors - temperature range -40...85° C



Design / length [mm]	Sensing range [mm]	Connection	Output	Order no.	Price
M12 / 70	7 nf	M12	3 / 2-wire; DC PNP/NPN; NO	IFM204	\$124.00
M12 / 70	4 f	M12	3-wire; DC PNP; NO	IFM205	\$141.00
M18 / 70	8 f	M12	3 / 2 -wire; DC PNP/NPN; NO	IGM200	\$124.00
M18 / 70	12 nf	M12	3 / 2 -wire; DC PNP/NPN; NO	IGM201	\$124.00
M18 / 70	12 nf	M12	3-wire; DC PNP; NO	IGM205	\$141.00
M30 / 70	12 f	M12	3 / 2 -wire; DC PNP/NPN; NO	IIM200	\$164.00
M30 / 70	22 nf	M12	3 / 2 -wire; DC PNP/NPN; NO	IIM201	\$164.00

Magnetic sensors - pressure resistance 500 bar



Design / length [mm]	Sensing range [mm]	Connection	Output	Order no.	Price
M12 / 93	1.8 f	M12	PNP; normally open	MFH200	\$267.00

Pressure sensors



Pressure range [bar]	Process connection	Electrical connection	Temperature [C°]	Output	Order no.	Price
0...400	G 1/4	M12 connector	-40...125	4...20 mA	PT5500	\$307.00
0...10	G 1/4	M12 connector	-40...125	4...20 mA	PT5504	\$299.00
0...250	G 1/4	DEUTSCH connector	-40...125	4...20 mA	PT5701	\$299.00
0...250	G 1/4	AMP connector	-40...125	4...20 mA	PT5601	\$299.00
0...250	G 1/4	DEUTSCH connector	-40...125	0.5...4.5 V	PU8701	\$299.00

Temperature sensors



Measuring range [C°]	Process connection	Electrical connection	Installation depth [mm]	Output	Order no.	Price
-50...150	G 1/4	M12 connector	25	4...20 mA	TA3105	\$386.00
-50...150	G 1/4	M12 connector	50	4...20 mA	TA3115	\$391.00
-50...150	G 1/4	M12 connector	25	0.5...4.5 V	TU3105	\$386.00
-50...150	G 1/4	DEUTSCH connector	25	0.5...4.5 V	TU4105	\$402.00



Type	Description	Order no.	Price
M12 sockets 4-pole (0.34mm² sensor) - IP69k, 4A max			
	2 m black, PUR cable	EVM001	\$45.00
	5 m black, PUR cable	EVM002	\$52.00
	10 m black, PUR cable	EVM003	\$62.00
	15 m black, PUR cable	EVM018	\$72.00
	25 m black, PUR cable	EVM014	\$97.00
	60 m black, PUR cable	EVM065	\$187.00
	2 m black, PUR cable	EVM004	\$45.00
	5 m black, PUR cable	EVM005	\$52.00
	10 m black, PUR cable	EVM006	\$62.00
	15 m black, PUR cable	EVM019	\$72.00
	25 m black, PUR cable	EVM012	\$97.00
	50 m black, PUR cable	EVM010	\$157.00
M12 sockets 5-pole (0.34mm² sensor) - IP69k, 4A max			
	2 m black, PUR cable	EVM036	\$47.00
	5 m black, PUR cable	EVM037	\$58.00
	10 m black, PUR cable	EVM038	\$77.00
	2 m black, PUR cable	EVM039	\$47.00
	5 m black, PUR cable	EVM040	\$58.00
	10 m black, PUR cable	EVM041	\$77.00

A-coded, M12 Wirable Plugs and Sockets, 4 & 5-Pole, IP69k



CR20xx field module wirable connector

Type	Description	Order no.	Price
M12 Wirable Plugs and Sockets, 4-pole & 5-pole, IP69k, 4A max			
	Wirable socket, straight, 4-pole	EVC810	\$37.00
	Wirable socket, straight, 5-pole	EVC814	\$40.00
	Wirable socket, angled, 4-pole	EVC811	\$37.00
	Wirable socket, angled, 5-pole	EVC815	\$40.00
	Wirable plug, straight, 4-pole	EVC812	\$37.00
	Wirable plug, straight, 5-pole	EVC816	\$40.00
	Wirable plug, angled, 4-pole	EVC813	\$37.00
	Wirable plug, angled, 5-pole	EVC817	\$40.00



Description	Order no.	Price
Wirable connector		
Wirable AMP socket for CR20xx field bus module	E12582	\$28.00



For product selection chart refer to page 42

- Large cable cross-section for voltage drop reduction
- Permanent vibration protection due to saw tooth contour
- Optimum sealing even when fastened by hand
- The mechanical end stop protects the O-ring against destruction

Technical data:

Operating voltage: 30 V AC / 36 V DC
 Current rating: 4 A
 Protection rating: IP 65, IP 67, IP 68, IP 69K
 in locked condition with the matching counterpart.
 Tightening torque: 0.6 Nm – 1.5 Nm
 Vibration / shock: 750 g, 1 million cycles

Cable:

Drain wire (screen): 0.75 mm²
 Voltage supply: 2 x 0.75 mm²
 CAN: 2 x 0.5 mm²
 Drag chain: > 5 million cycles

Approvals:

cULus

Applications:

EVC factory automation and mobile machines

Type	Description	Order no	Price
Connection cable M12 connector			
	2.0 m	EVC943	\$81.00
	5.0 m	EVC944	\$164.00
	2.0 m	EVC945	\$81.00
	5.0 m	EVC946	\$164.00
Connection cable M12 socket			
	2.0 m	EVC939	\$84.00
	5.0 m	EVC940	\$168.00
	2.0 m	EVC941	\$84.00
	5.0 m	EVC942	\$168.00

CAN bus programming cables



Type	Description	Order no.	Price
	CAN devices to the USB interface of a PC, R360/CAN-Interface/CANFox	EC2112	\$522.00
	Programming cable set for CAN interface, R360/CABLE/ CAN-fox-Basic	EC2114	\$259.00

AS-i Bus system components

AS-i Masters



Description	Order no	Price
AS-i controller / gateways (colour display for clear diagnosis & set-up)		
AS-i Profibus gateway, 2 AS-i masters with M4 profile	AC1412	\$2,823.00
ifm SPS Profisafe over Profinet gateway / safety master	AC402S	\$3,836.00
EtherNet/IP device interface, 2x AS-i masters with M4 Profile	AC1424	\$3,199.00
AS-i EtherNet/IP gateway; Number of AS-i masters 1; terminals	AC1421	\$2,428.00
AS-i EtherNet/IP gateway; Number of AS-i masters 2; terminals	AC1422	\$3,003.00
AS-i EtherNet/IP gateway with safe preprocessing	AC4225	\$3,836.00

AS-i IO-Link masters



Type	Description	Order no.	Price
	IO-Link Master AS-i 4P IP67	AC6000	\$611.00
	IO-Link Master AS-i 4P IP69K	AC6001	\$712.00
	IO-Link Master AS-i 2P IP67	AC6002	\$596.00
	IO-Link Master AS-i 2P IP69K	AC6003	\$693.00
	4-port (AS-i and AUX)	AC2950	\$208.00
	2-port (AS-i)	AC2951	\$258.00

AS-i system power supplies



Current / peak at 24 V	Input voltage [V AC]	Order no.	Price
2.8 A	100...120 / 200...240	AC1256	\$615.00
4 A	100...120 / 200...240	AC1254	\$765.00
4 A	24v DC	AC1257	\$876.00
8 A	380...480	AC1253	\$1,275.00
8 A	115 / 230	AC1258	\$1,079.00
2 x 4 A	115 / 230	AC1212	\$1,374.00

AS-i I/O field modules - IP69K





Type	Description	Article no.	Price
Modules			
	ProcessLine 4DI-Y 4DO IP69K (fully potted module)	AC2953	\$408.00
	ProcessLine 4DI-Y IP69K (fully potted module)	AC2954	\$610.70
	IP 69K, 8-way splitter box. Passive ProcessLine module, SS316L, Sockets M12	AC2900	\$427.00
	FC splitter · M12 socket · SS316L / 1.4404 / Blanks: FPM / O-ring: EPDM	E70354	\$99.00
	FC splitter · SS316L / 1.4404 / Blanks: FPM / O-ring: EPDM	E70377	\$89.00

AS-i Bus system components

Smartline modules



Type	Description	Order no.	Price
	SmartL25 4DI 4DO T C	AC3200	\$343.00
	SmartL25 4DI AUX 4DO T C	AC3201	\$343.00
	SmartL25 4DI 4DO R C	AC3220	\$377.00
	SmartL25 4DI AUX 4DO R C	AC3221	\$377.00
	SmartL25 AS-i Repeater III	AC3226	\$647.00
	SmartL25 4DI 4DO T C	AC3251	\$323.00
	SmartL25 4DI 2DO R C	AC3256	\$285.00
	SmartL25 4DI AUX 4DO T C	AC3257	\$284.00
	ClassicLine 2SI 2LO	AC5055	\$352.00
	ClassicL 2SI AUX 2DOT 2LO OSSD	AC5085	\$444.00

Safe AS-Interface ClassicLine module with quick mounting technology



Type	Description	Order no.	Price
	ClassicLine 2SI 2LO	AC5055	\$352.00
	ClassicL 2SI AUX 2DOT 2LO OSSD	AC5085	\$444.00

Compact modules - IP67





Type	Description	Order no.	Price
	CompactModule 4DI M12	AC2410	\$339.00
	CompactModule 2DI 2DO T M12	AC2411	\$437.00
	CompactModule 4DI 4DO T M12	AC2412	\$562.00

Accessories

Type	Description	Order no.	Price
	AS-Interface flat cable seal	AC3003	\$46.00

Electronic Modules

Type	Description	Order no.	Price
	AS-Interface PCB module AS-i pcb 2-DI/1-DO	AC2729	\$239.00
	AS-Interface PCB module PCB 4DI 4DO T W A/B	AC2750	\$297.00
	AS-Interface PCB module PCB 4DI 4DO T C A/B	AC2752	\$297.00

AS-i Bus system components

AS-i safety

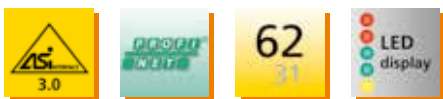

Type	Description	Order no.	Price
AS-i controller and gateways (colour display for clear diagnosis & set-up)			
	AS-i PROFINET gateway with safe preprocessing	AC402S	\$3,836.00
	AS-i Ethernet/IP gateway with safe preprocessing	AC422S	\$3,836.00
	AS-i EtherCAT gateway with safe preprocessing	AC432S	\$4,061.00

Type	Safety Outputs	Non-safe Outputs	Order no.	Price
	SmartLine SafetyModule		AC009S	\$496.00
	SmartLine Module 2SO IP20		AC030S	\$910.00
	ClassicL 2SI 2DOT 2LO OSSD		AC507S	\$444.00
	ClassicLine 4DI-Y II 3D		AC515A	\$375.00
	AS-i Safety Platine		AC015S	\$257.00
	E-stop illuminated IP67		AC010S	\$523.00

Type	Description	Order no.	Price
	AS-i addressing unit	AC1154	\$902.00
	AS-i Tuner IP67, diagnostic module; Connector	AC1146	\$1,378.00
	AS-Interface passive bus termination	AC1147	\$236.00
	AS-Interface flat cable insulation displacement connector	E75005	\$21.00
	Flat cable 100 m EPDM (yellow), 2 x 1.5mm ²	E74000	\$532.00
	Flat cable 50 m EPDM (yellow), 2 x 1.5mm ²	E74002	\$305.00
	Flat cable 500 m EPDM (yellow), 2 x 1.5mm ²	E74003	\$2,504.00
	Flat cable EPDM 100 m (yellow), 2 x 1.5mm ²	E74005	\$592.00
	Flat cable 100 m EPDM (black), 2 x 1.5mm ²	E74010	\$595.00
	Flat cable 500 m EPDM (black), 2 x 1.5mm ²	E74013	\$2,818.00
	Flat cable 100 m TPE (yellow), 2 x 1.5mm ²	E74200	\$674.00
	Flat cable 100 m TPE (black), 2 x 1.5mm ²	E74210	\$781.00
	Flat cable 100 m TPE (red), 2 x 1.5mm ²	E74220	\$1,211.00
	Flat cable: 100 m, TPE-PVC compound, yellow; 2 x 1.5 mm ²	E74300	\$1,180.00
	Flat cable: 100 m, TPE-PVC compound, black; 2 x 1.5 mm ²	E74310	\$1,292.00
	Flat cable 200 m EPDM (yellow), 2 x 2.5mm ²	E74406	\$1,546.00
	Flat cable 200 m EPDM (black), 2 x 2.5mm ²	E74416	\$1,546.00
	FC Splitter AS-i UL	E70581	\$45.00
		FC Splitter AS-i M12 FC top UL	E70585
	FC Splitter AS-i / AUX M12 UL	E70587	\$74.00

Go ifmonline!

Browse, select, order
in the ifm webshop
ifm.com/au



Why use ifm e-Shop?

Wide product offering

ifm's extensive portfolio is structured by product groups, making it easy to browse by application.

Personalised pricing

Log in to see both list and your net prices.

Live stock availability

See current stock levels for AU-held items and get accurate ETAs for non-stock products.

Free Freight under 20kg

Free Freight on all orders under 20kg.

Product Selector

Quickly narrow your options using key technical criteria to find the right product.

Compare options

Use the comparison tool to view up to 3 products side-by-side, with differences clearly highlighted.

Smart search engine

The full-text search helps you instantly find products, documentation, and topics relevant to your interest.

Quotations

Generate your own PDF quote with net prices.

Full order history

Access your previous orders, invoices, and tracking info all in one convenient place.

Order anytime

Purchase online 24/7 at www.ifm.com/au.

Free Freight On All Orders Under 20kg!

Deliveries for >20kg are charged based on weight and shipping destination.

Shop smart, shop eShop!

www.ifm.com/au



Scan here to register
for e-Shop to purchase
immediately.



ifm – close to you!



Go **ifm**online!

Browse, select, order
in the ifm webshop

www.ifm.com/au



National Phone: 1300 365 088

HEAD OFFICE

Melbourne
ifm efector pty ltd
Suite 3, 745 Springvale Road
Mulgrave VIC 3170

SOUTH AUSTRALIA

Adelaide
Suite 28-T8 Tonsley
6 MAB Eastern Prom
Tonsley SA 5042

NEW SOUTH WALES

Sydney
Quad 1, Level 1, Suite 1.01
8 Parkview Drive
Sydney Olympic Park NSW 2127

QUEENSLAND

Gold Coast
Unit 1, Level 1, 1 Zupp Drive
Ormeau QLD 4208

TASMANIA

Launceston
City Mill Business Centre
76 York Street
Launceston TAS 7250

WESTERN AUSTRALIA

Perth
Allendale Square,
Ground Floor Plaza
79 St Georges Terrace
Perth WA 6000
Australia

5 YEARS
Warranty
on ifm products

Disclaimer:

While every effort has been made to ensure the accuracy and usefulness of this document please note that contents including prices may change without notice. You are advised to refer to www.ifm.com/au for comprehensive technical data current prices and our Australia terms and conditions of trade. No liability will be accepted for errors, omissions or amendments to product specifications or prices. Prices shown are AU\$ ex. ifm's Mulgrave store and exclude freight charges and GST.